

**Product Code**  
**PB000-11**  
**H=3.2**



Nozzle 100 10  
 100mmx10mm

**Product Code**  
**PH000001**



Nozzle 100 15  
 100mmx15mm

**Product Code**  
**PH000004**



Nozzle 100 5  
 100mmx5mm

**Product Code**  
**PH000003**



Nozzle 22 22  
 22mmx22mm

**Product Code**  
**PH000005**



Nozzle 100 10  
 100mmx10mm

**Product Code**  
**PH000006**



**Four in one**

**Product Code**  
**PH0000B1**



**Product Code**  
**CJ50**  
**W 15 H 50**



**Product Code**  
**CJ30**  
**W 9 H 30**



**Product Code**  
**CJT11**  
**W 9.4 H 12**

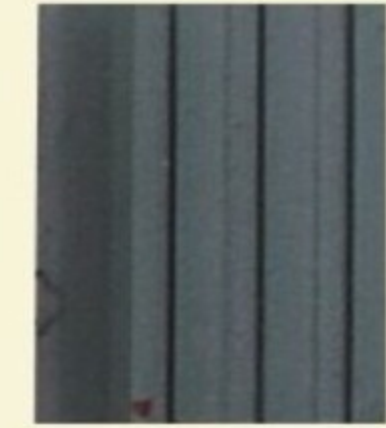

**Product Code**  
**L-STRIP**  
**W 4 H 25**

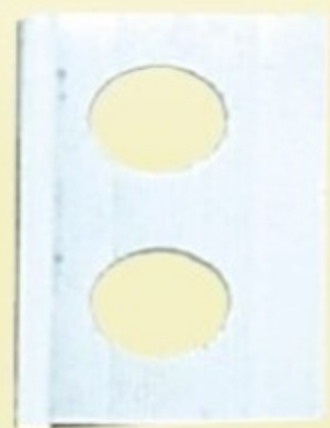

**Product Code**  
**TD11**  
**W 2.3 H 12**



**Product Code**  
**PH64A (S0000005)**



**Product Code**  
**PH61B (S0000006)**

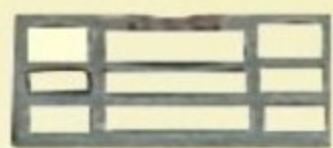

**Product Code**  
**PBQD-B**  
**W23.6 H13**



**Product Code**  
**PH63C (S0000007)**



**Product Code**  
**PH62D (S0000008)**

# Plaster Beacons

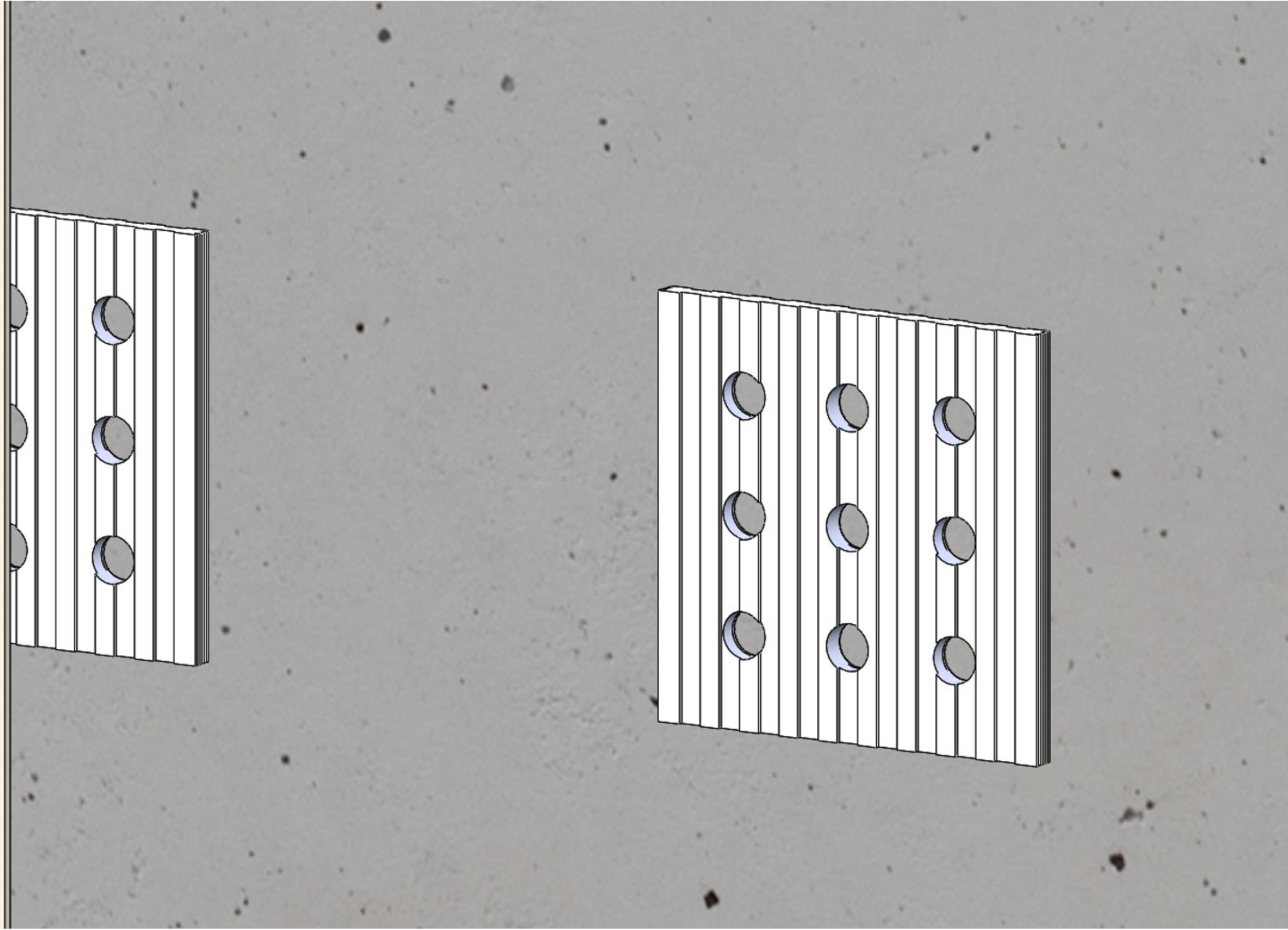

Product description:

Apply the solution in small portions and press plaster beacons to the solution as a rule.

Feature:

Improve working efficiency and make the walls perfectly smooth.

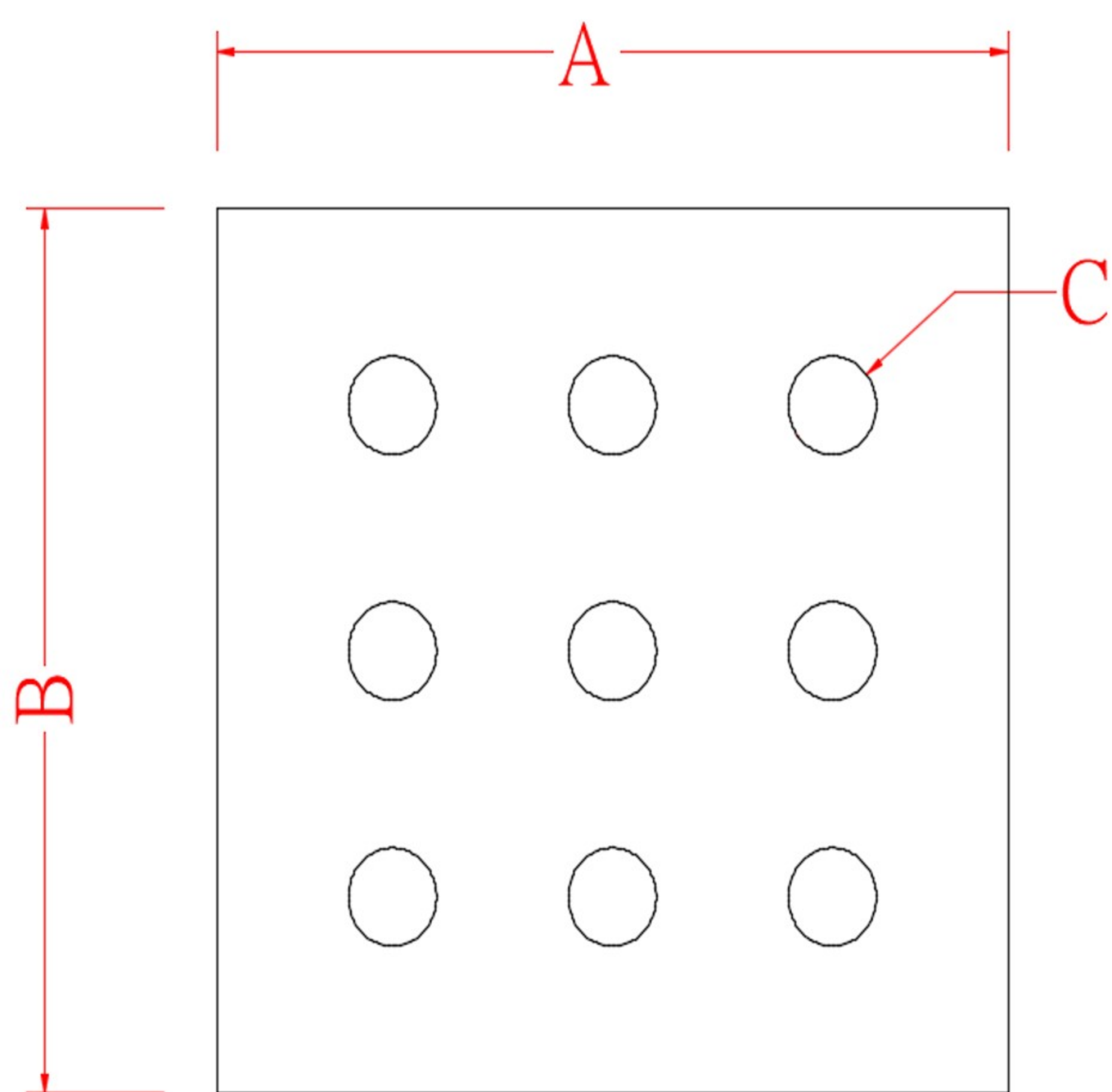

	A(mm)	B(mm)	C(mm)
PB000-12	50	50	5
PB000A12	45	45	5
PB000A13	45	45	5
PB000B12	45	45	0
PB000C12	50	50	0
PB000C13	50	50	0

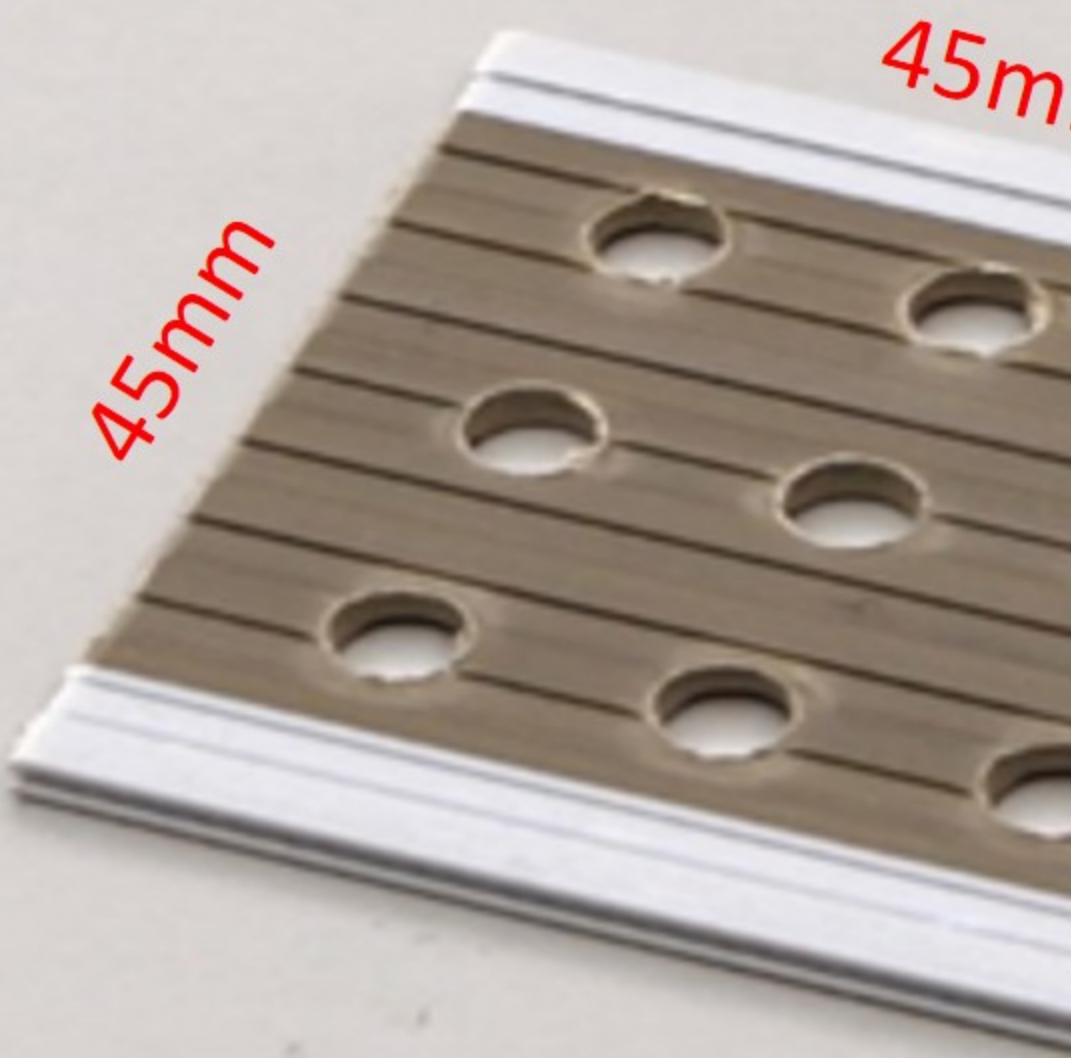
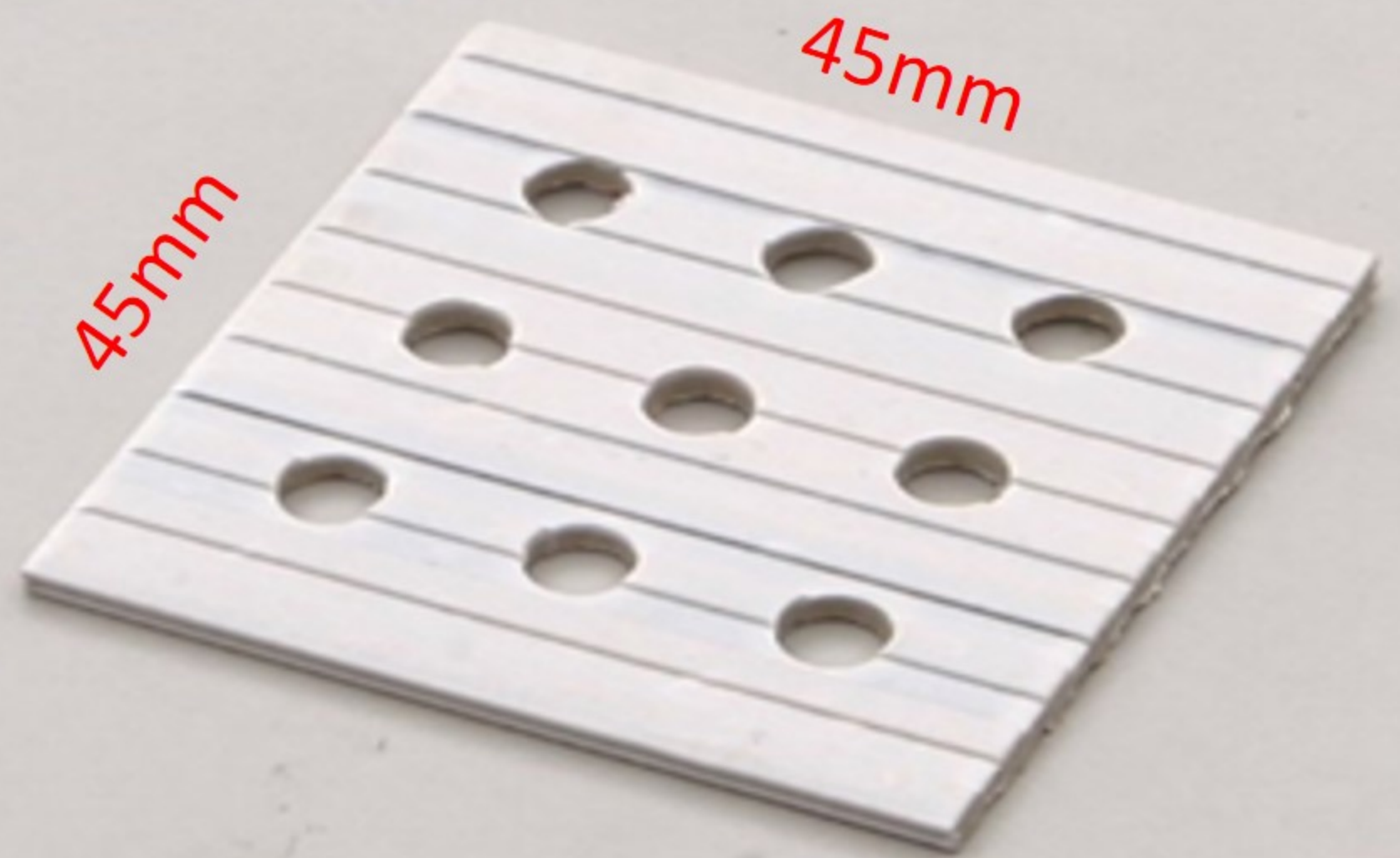
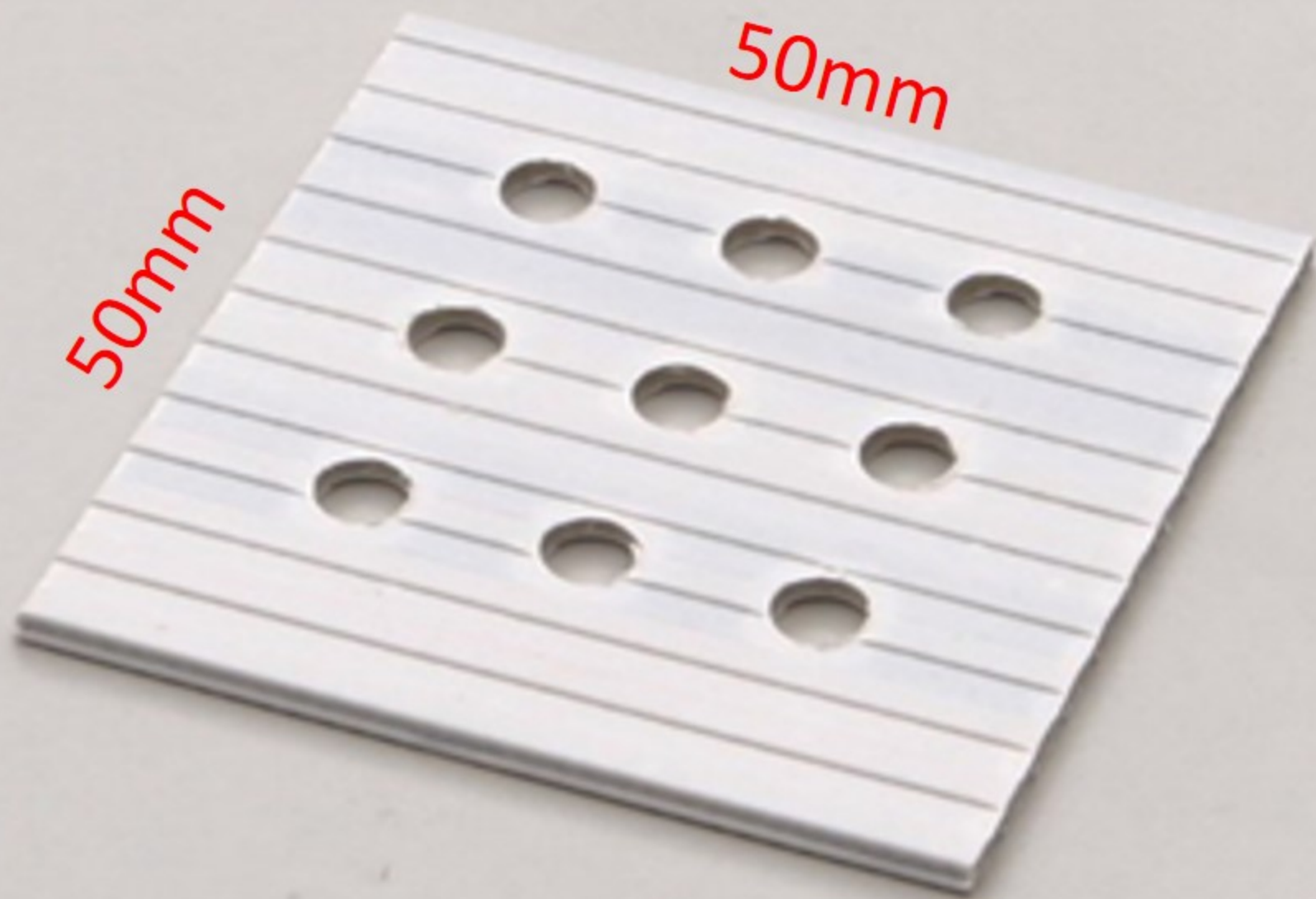

# Sorts of Plaster Beacons

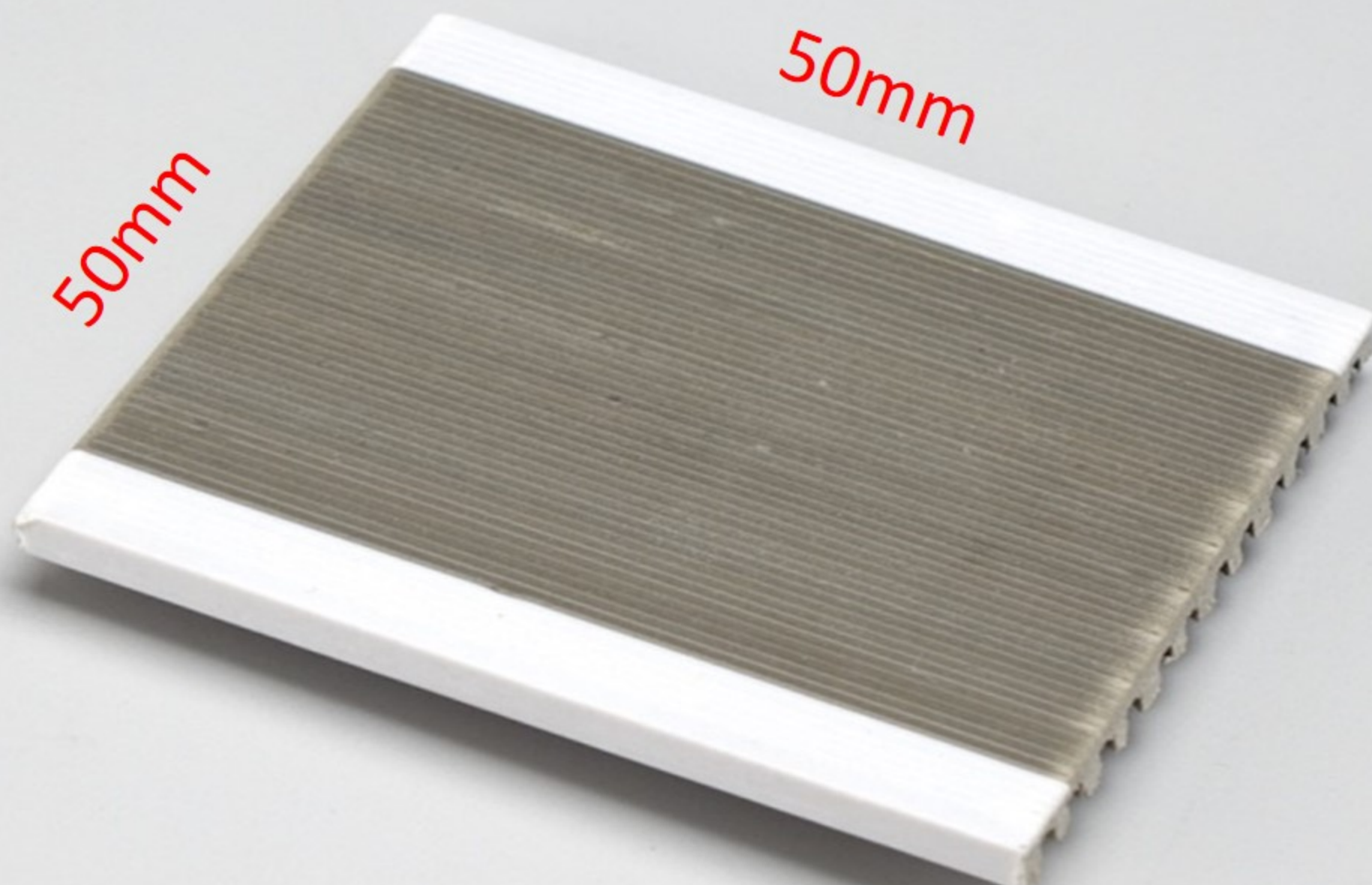
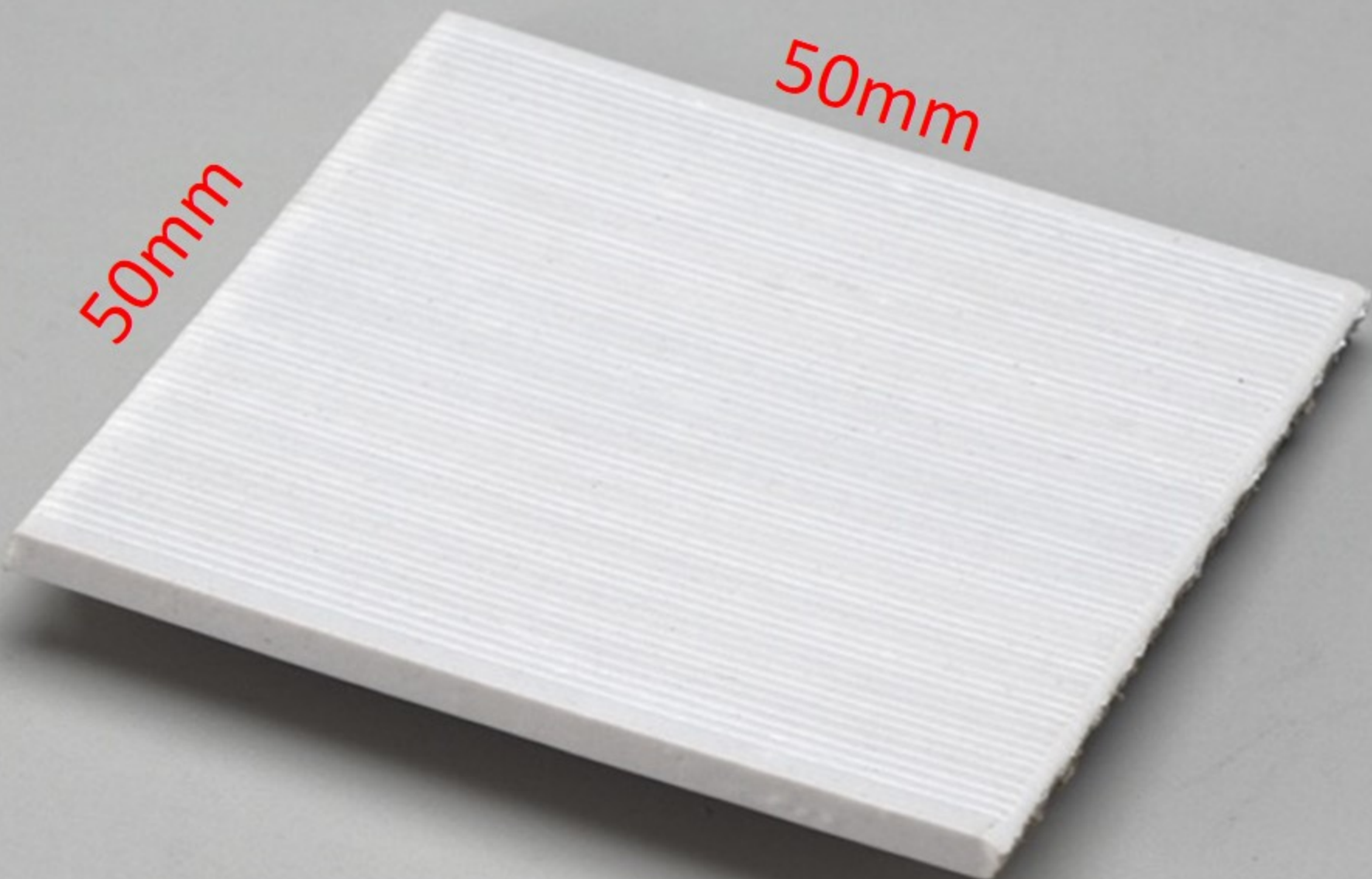
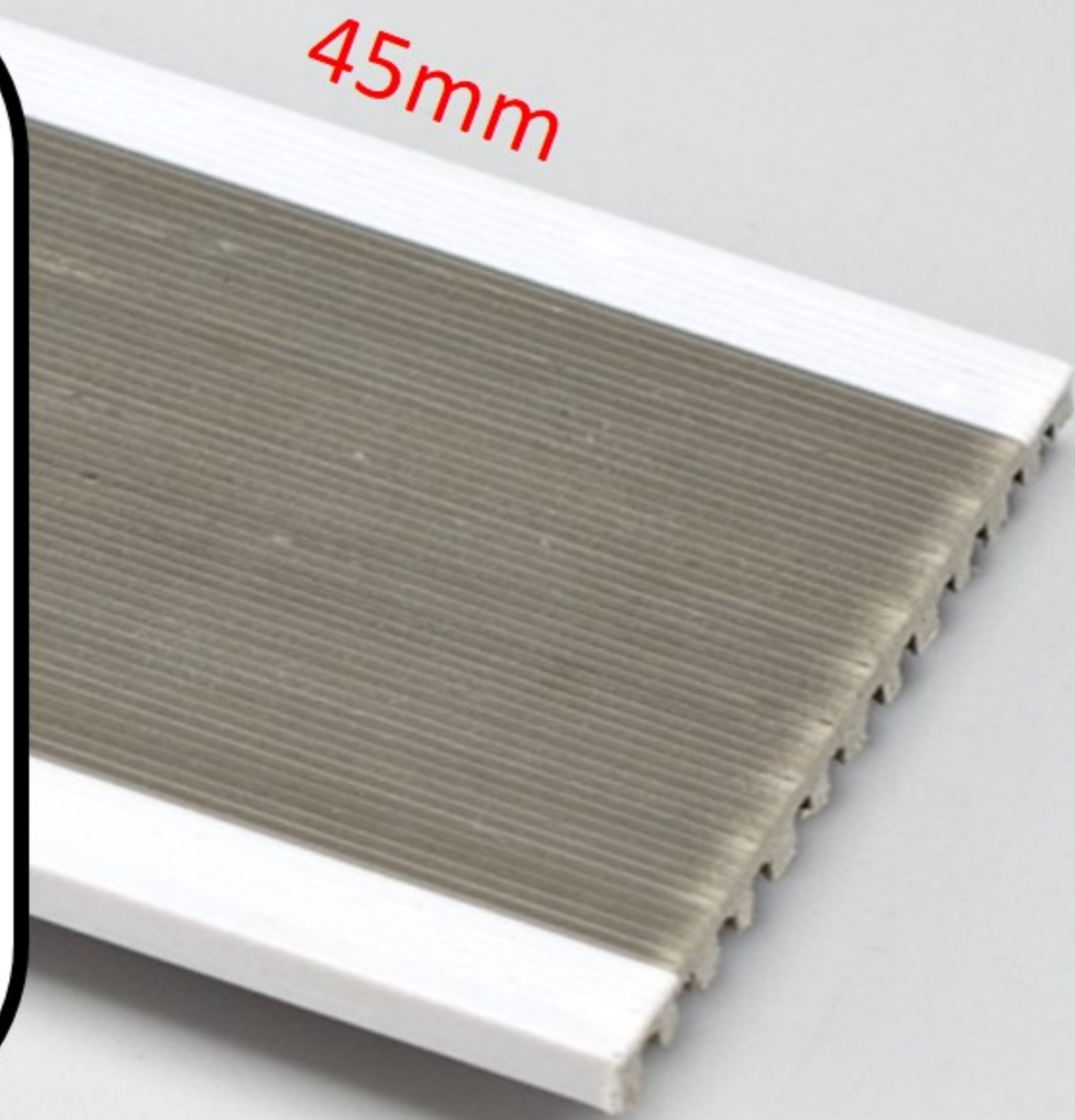



PB000-12



PB000A12



PB000A13

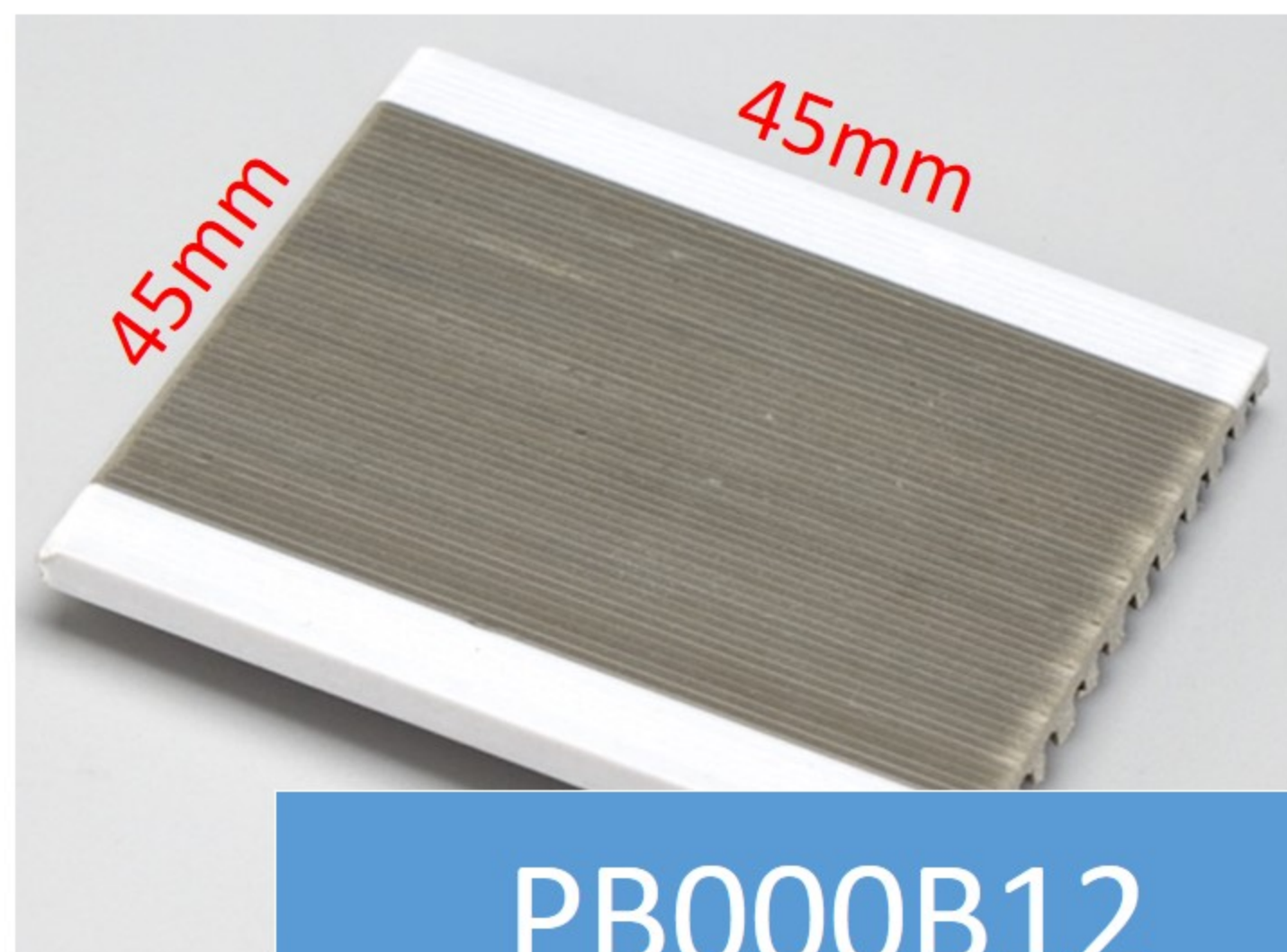

PB000B12

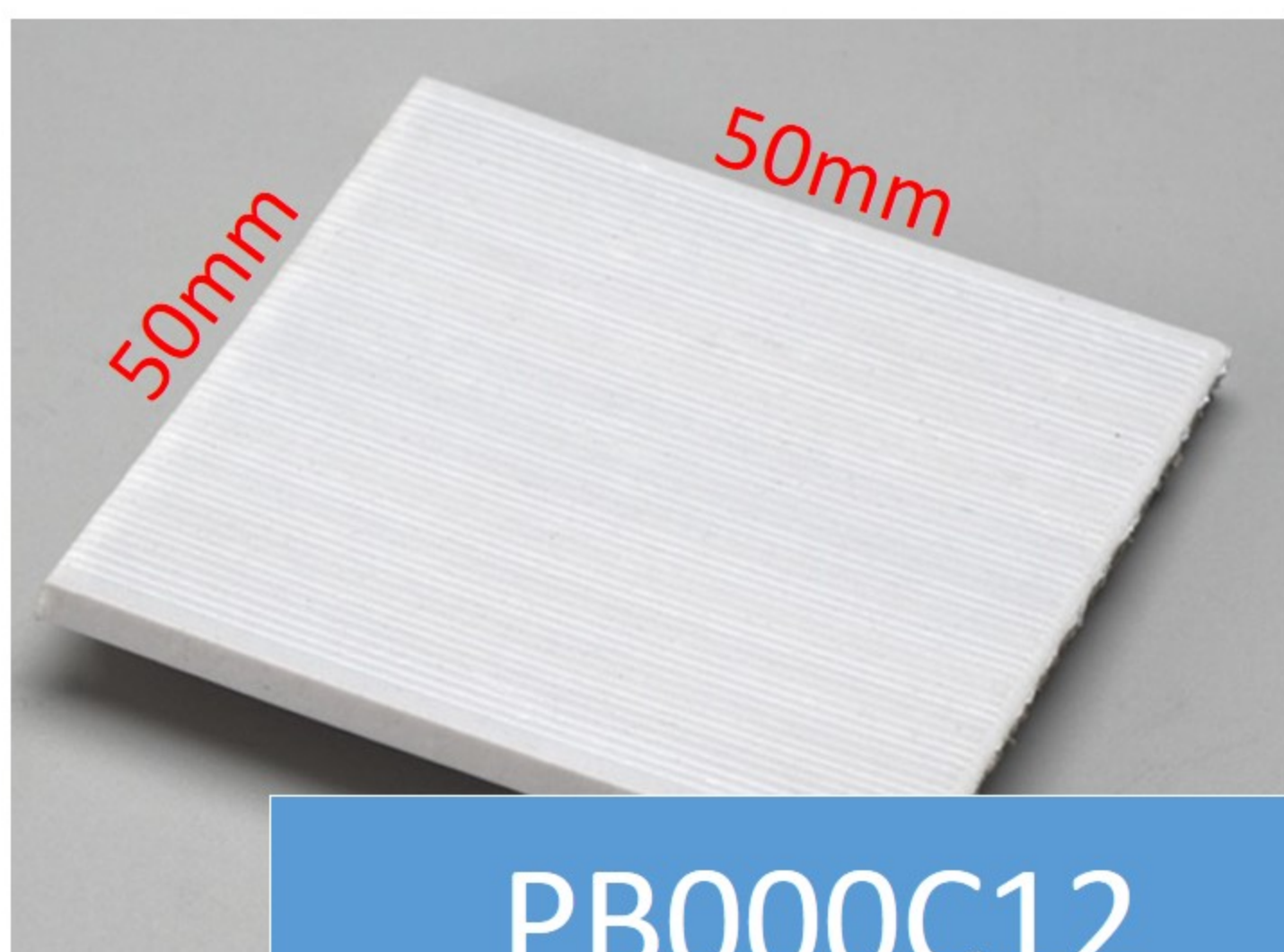

PB000C12

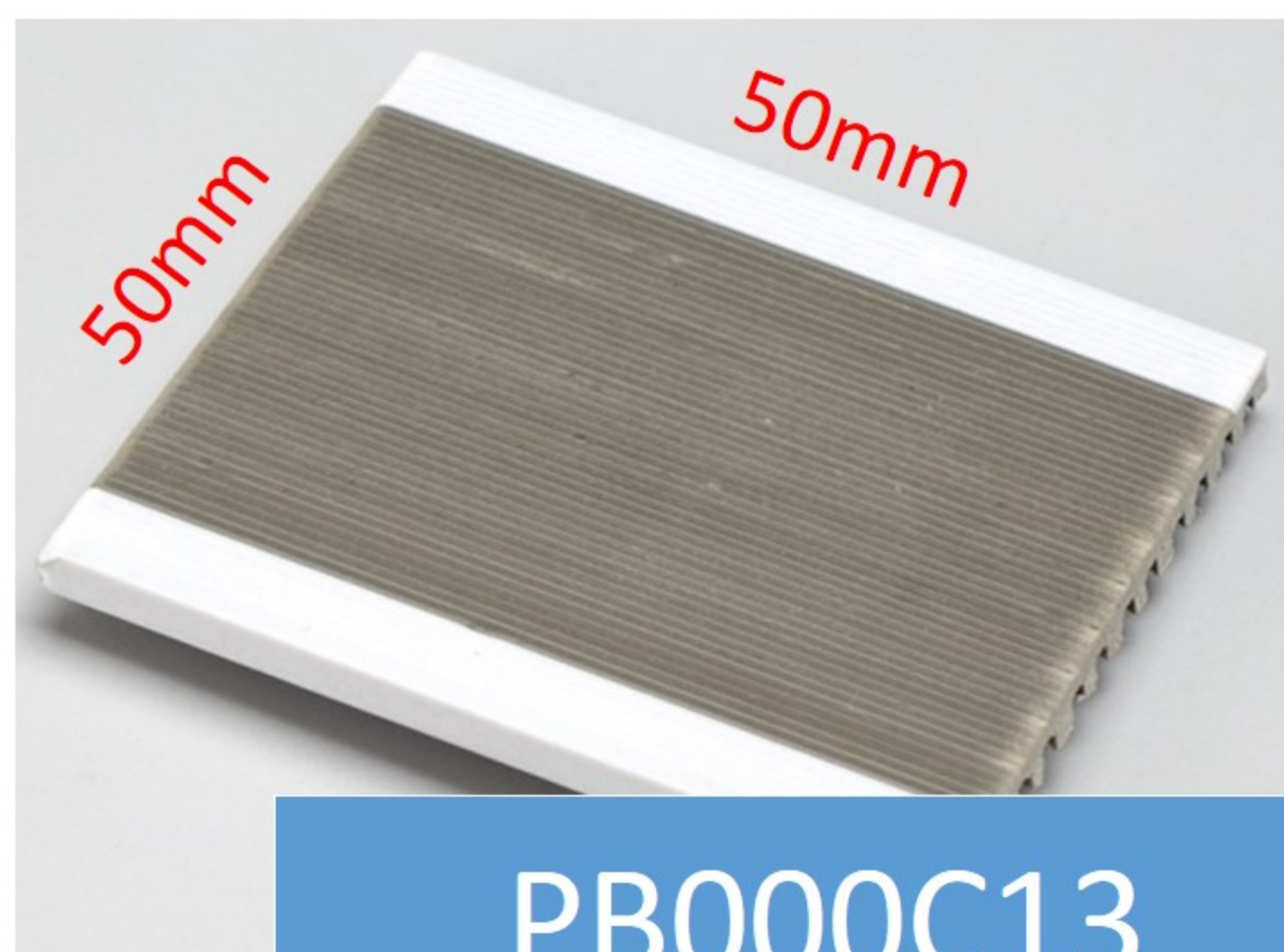

PB000C13

# Control Joint (CJ)

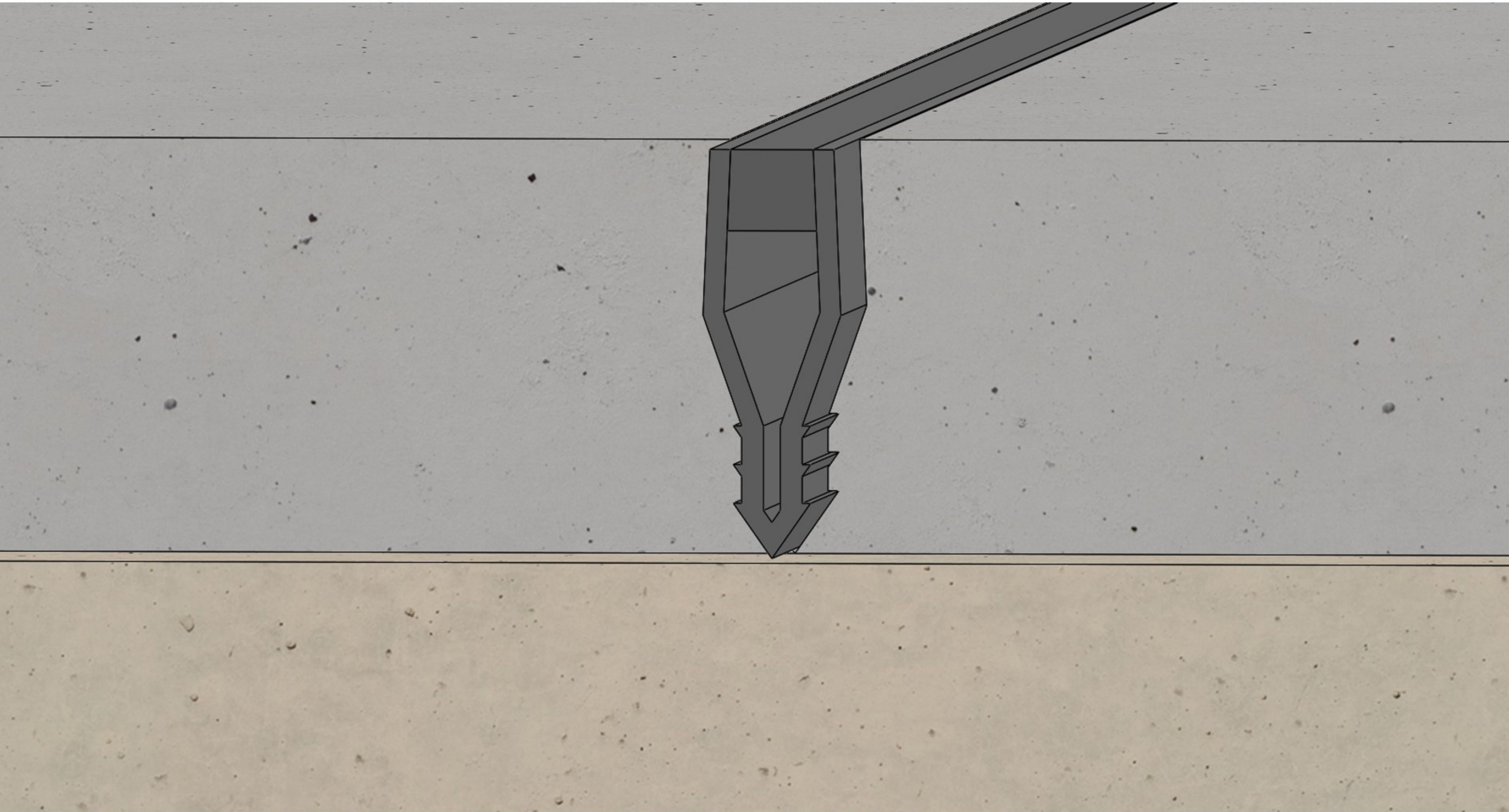

## Product description:

The product provides good spacing between concrete slabs and to create artificial planes of weakness where minor stresses can dissipate without forming cracks.

## Feature:

It improves working efficiency and cut down the labor costs.

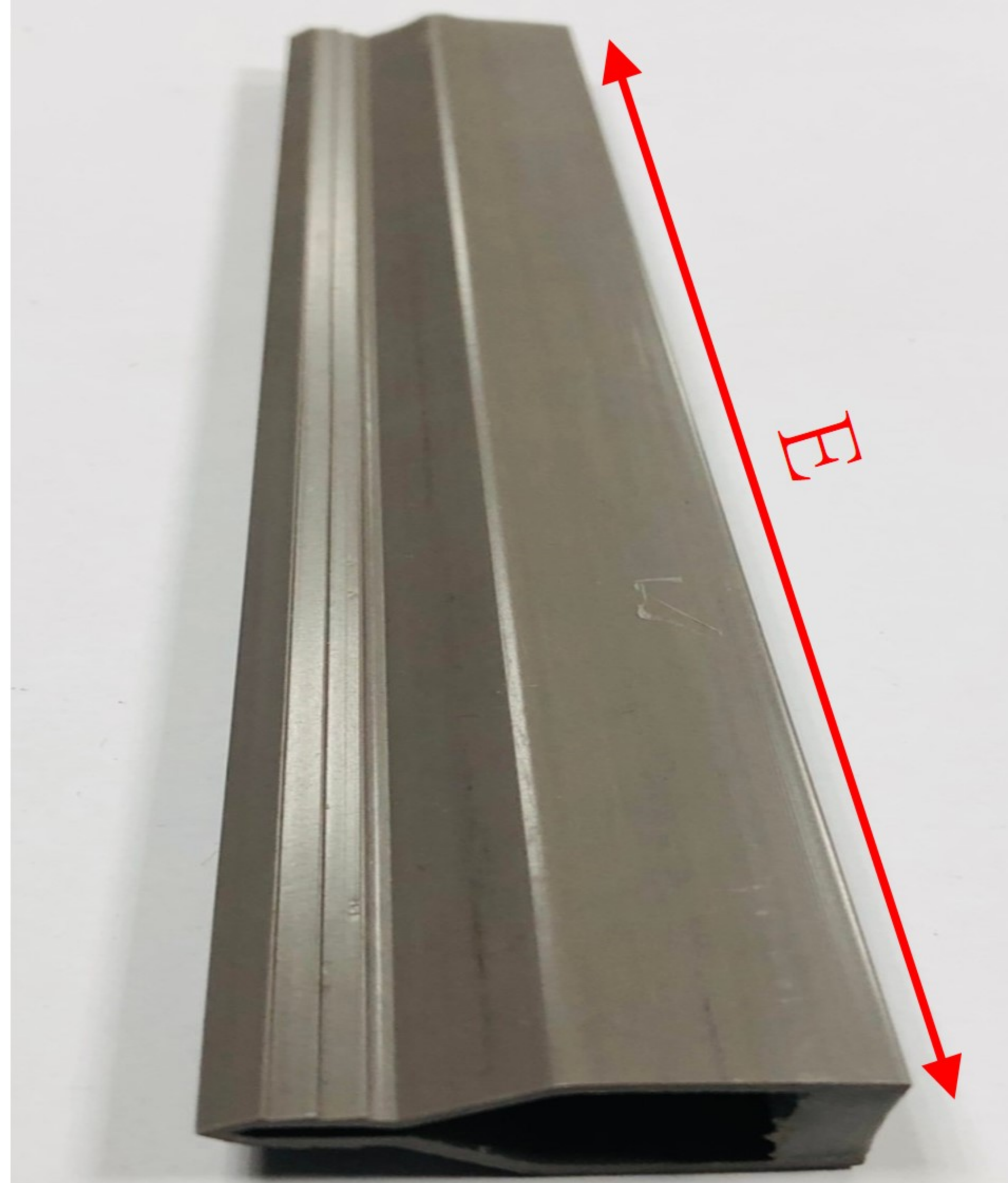
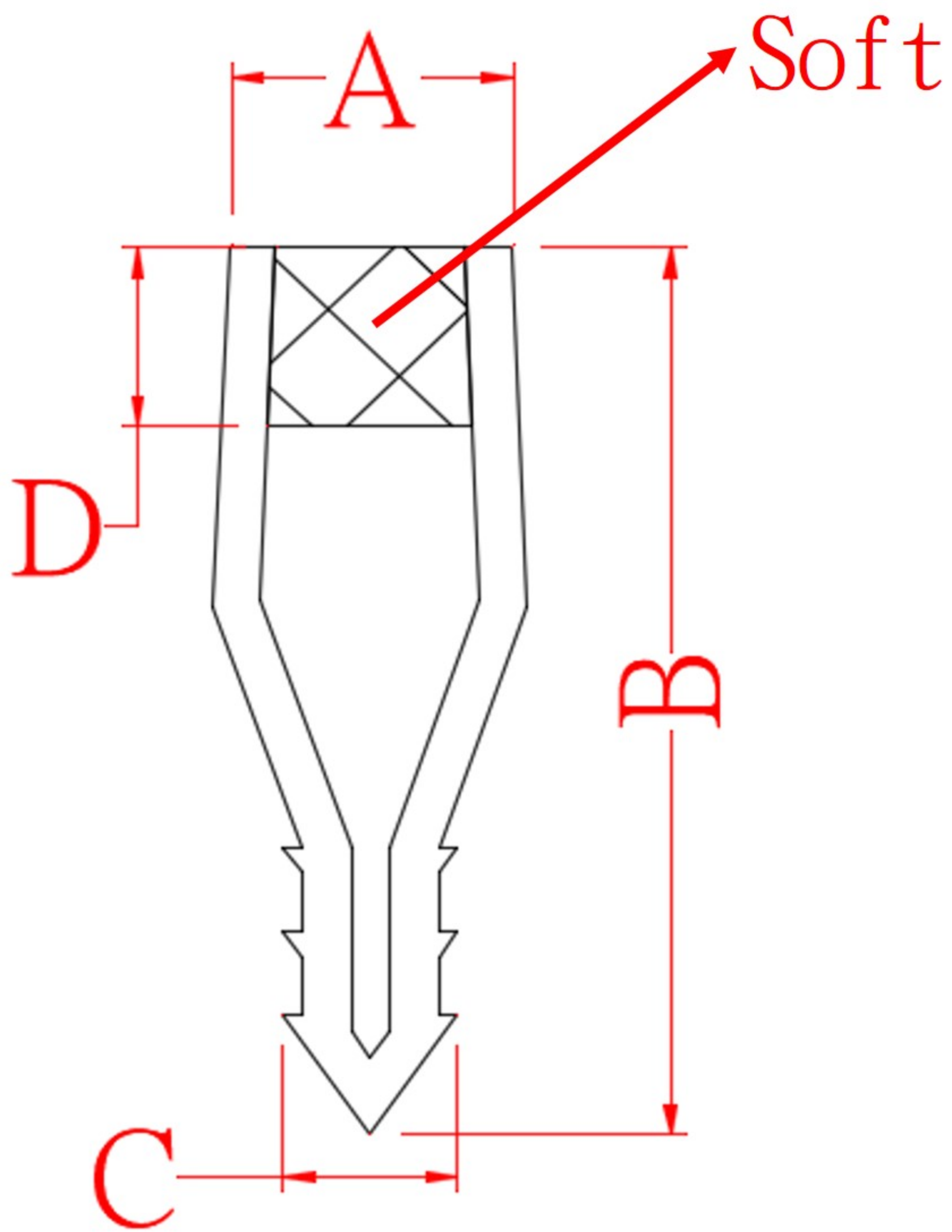

	A(mm)	B(mm)	C(mm)	D(mm)	E(m)
CJ30	9	30	5.6	6	3.0
CJ40	15	40	5.5	6	3.0
CJ50	15	50	5.5	6	3.0



# Control Joint (CJT)

## Product description:

The product provides good spacing between concrete slabs and to create artificial planes of weakness where minor stresses can dissipate without forming cracks.

## Feature:

It improves working efficiency and cut down the labor costs.



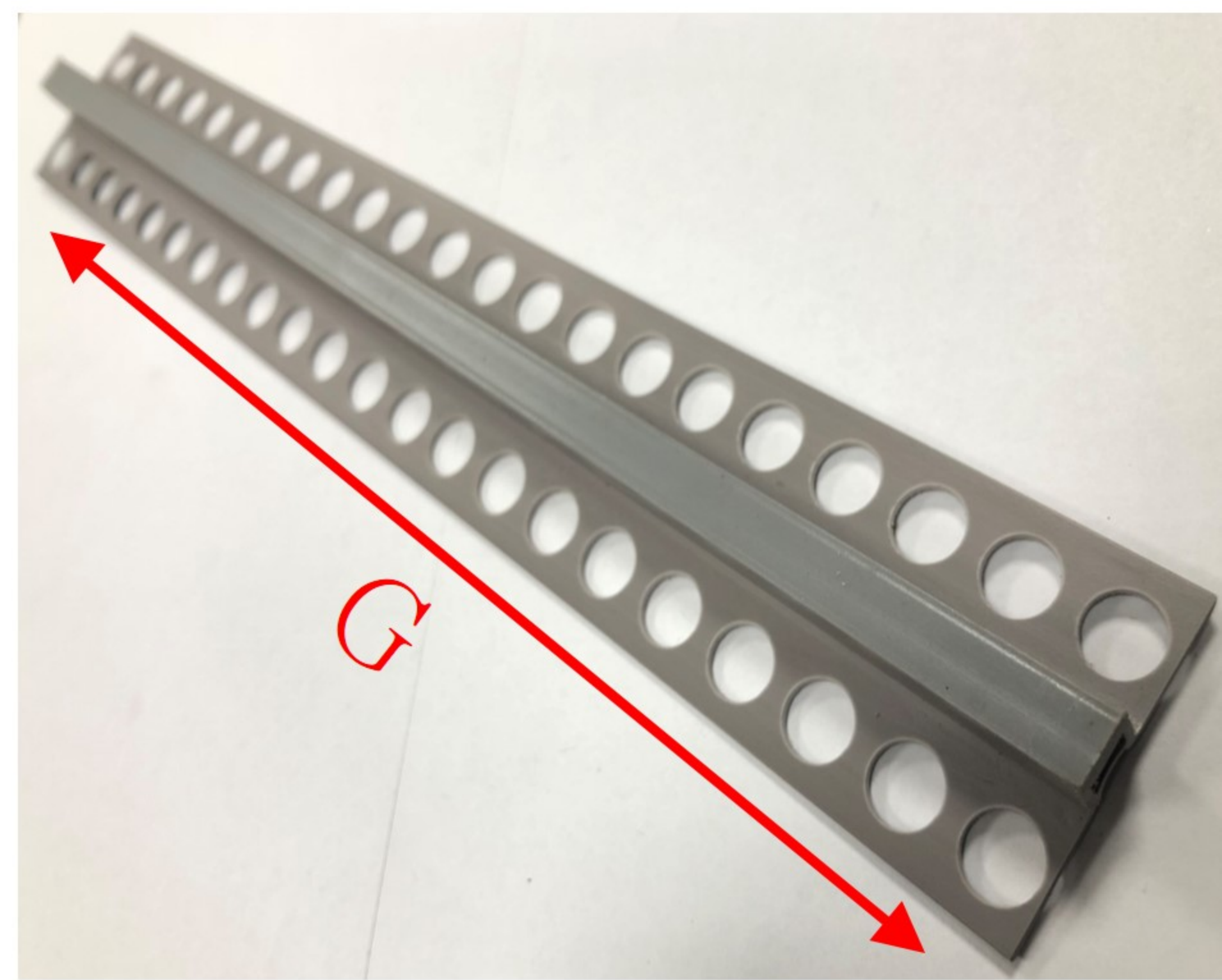
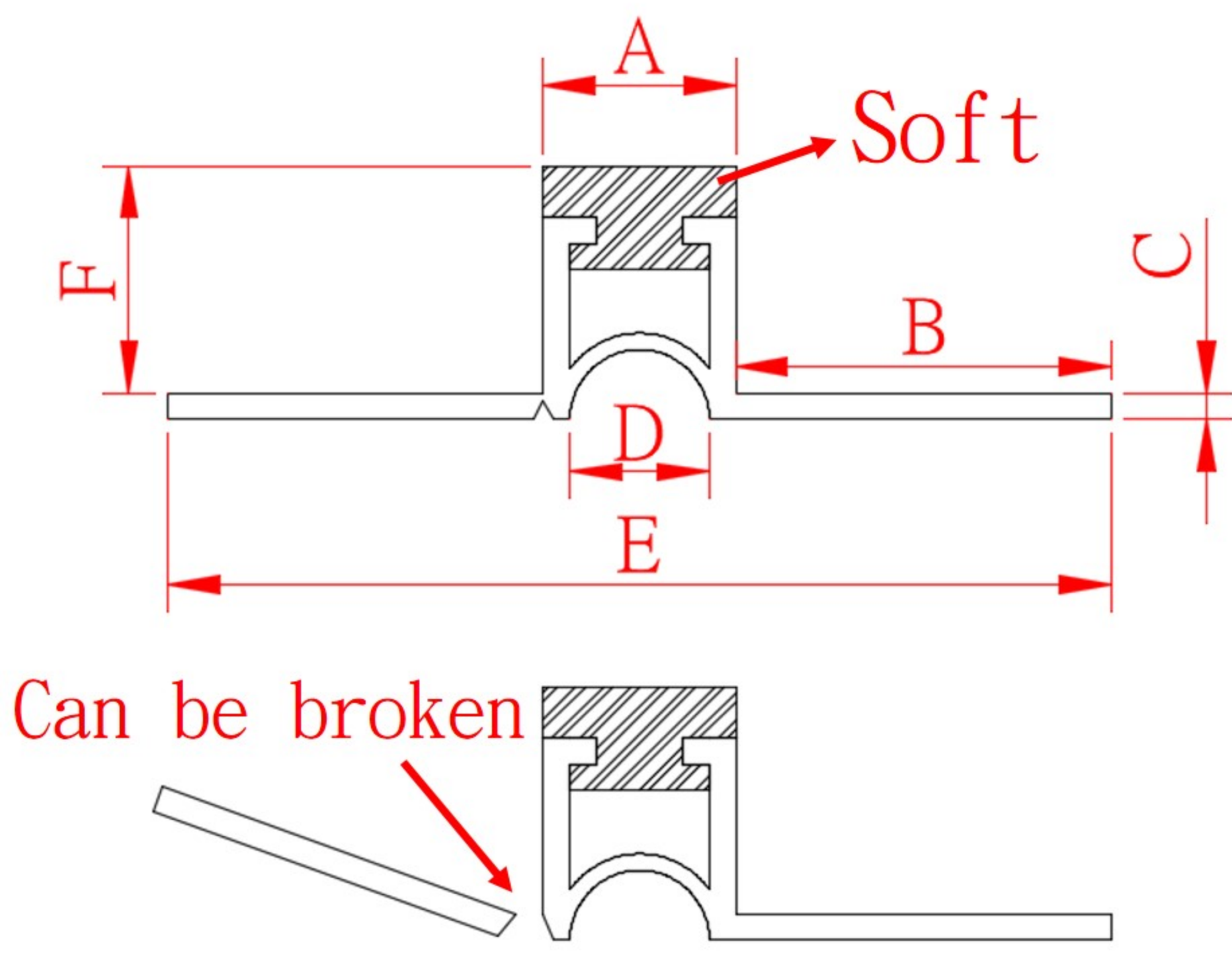

A(mm) B(mm) C(mm) D(mm) E(mm) F(mm) G(m)

CJT11 9.4 18.3 1.3 6.8 46 11 3.0

# Control Joint (L-STRIP)

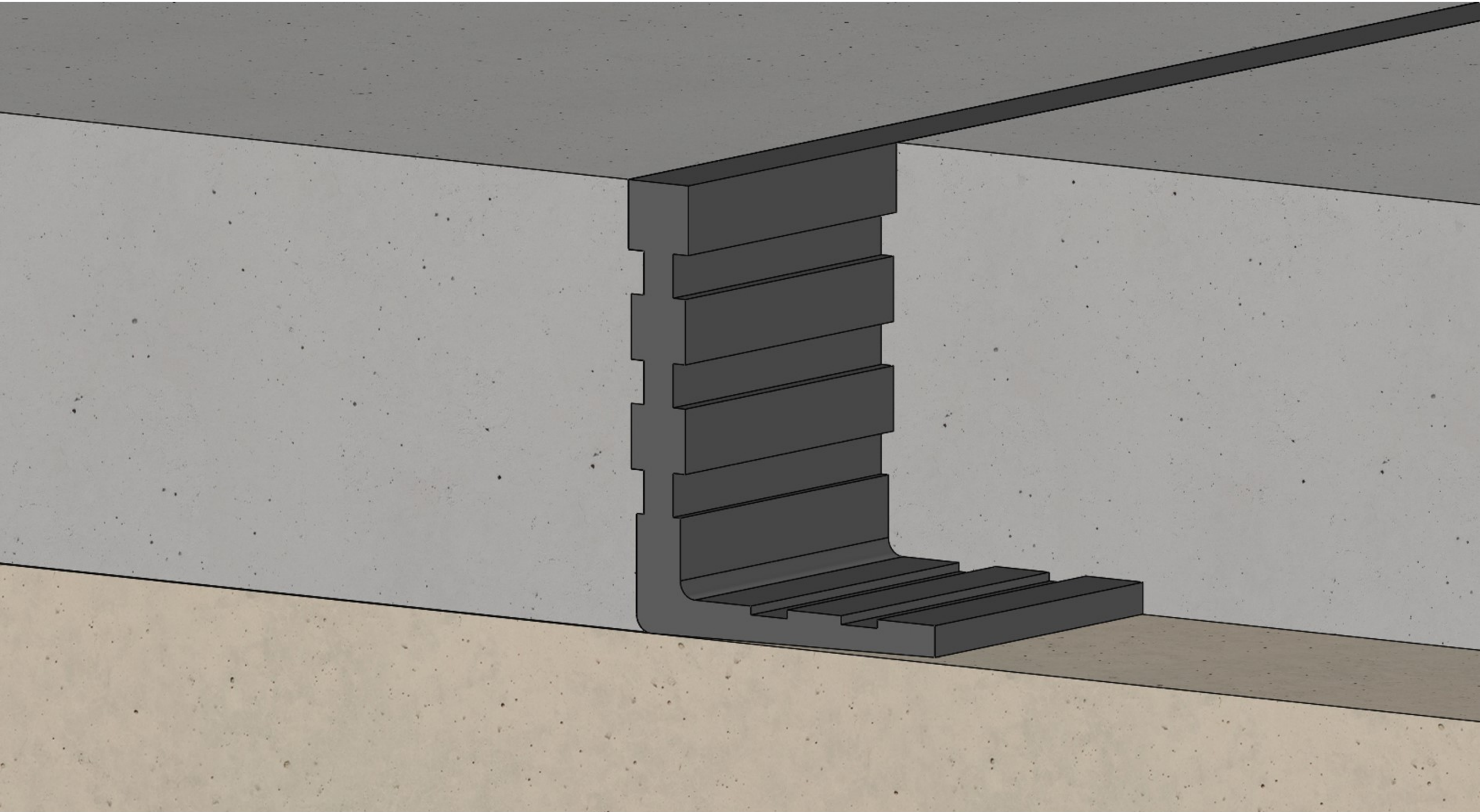

## Product description:

The product provides good spacing between concrete slabs and to create artificial planes of weakness where minor stresses can dissipate without forming cracks.

## Feature:

It improves working efficiency and cut down the labor costs.

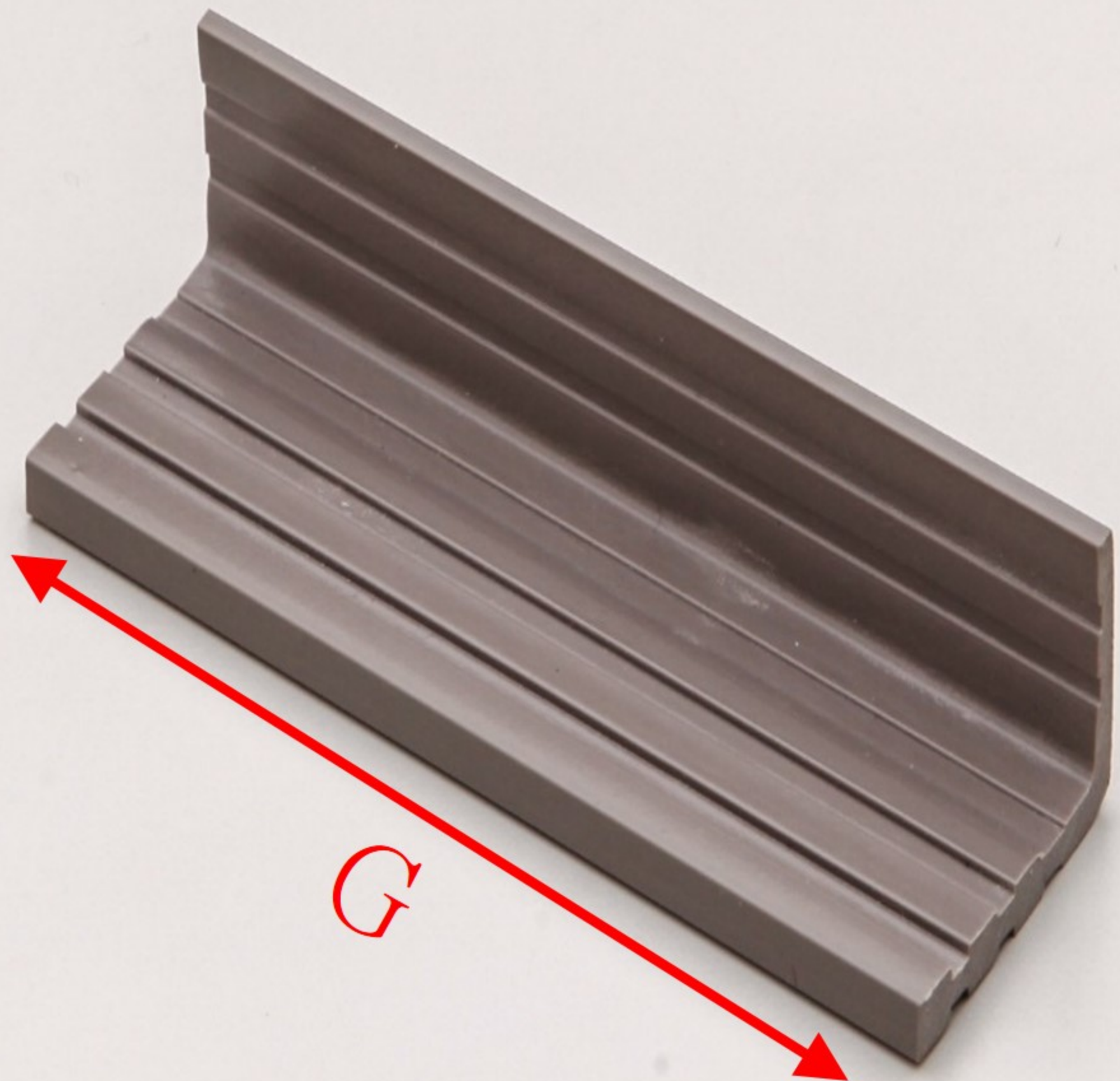
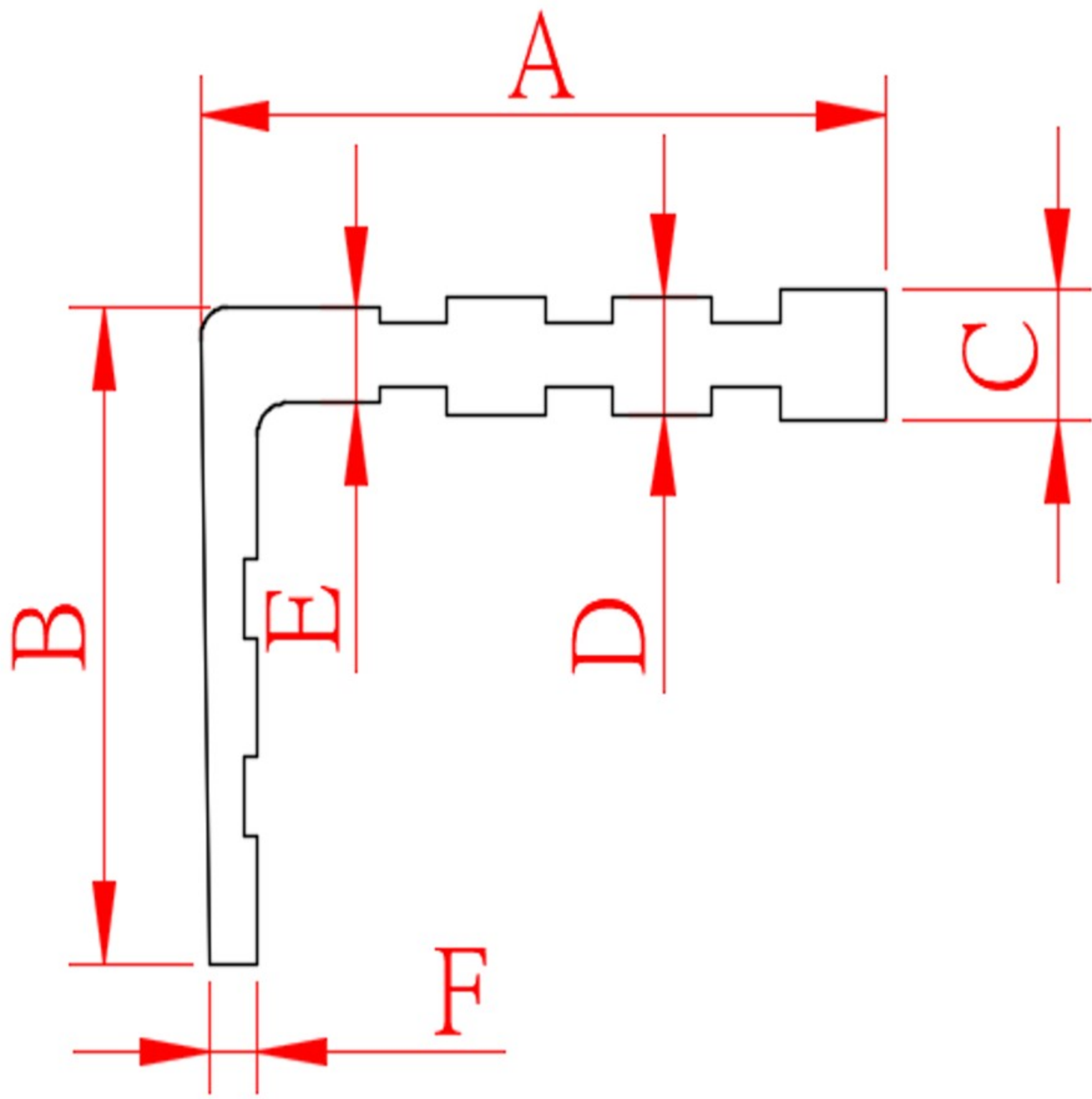

	A	B	C	D	E	F	G
	(mm)	(mm)	(mm)	(mm)	(mm)	(mm)	(m)

L-STRIP	25.5	20.5	4.2	3.7	3	1.8	3.0
---------	------	------	-----	-----	---	-----	-----

# Aluminum Plaster Ruler

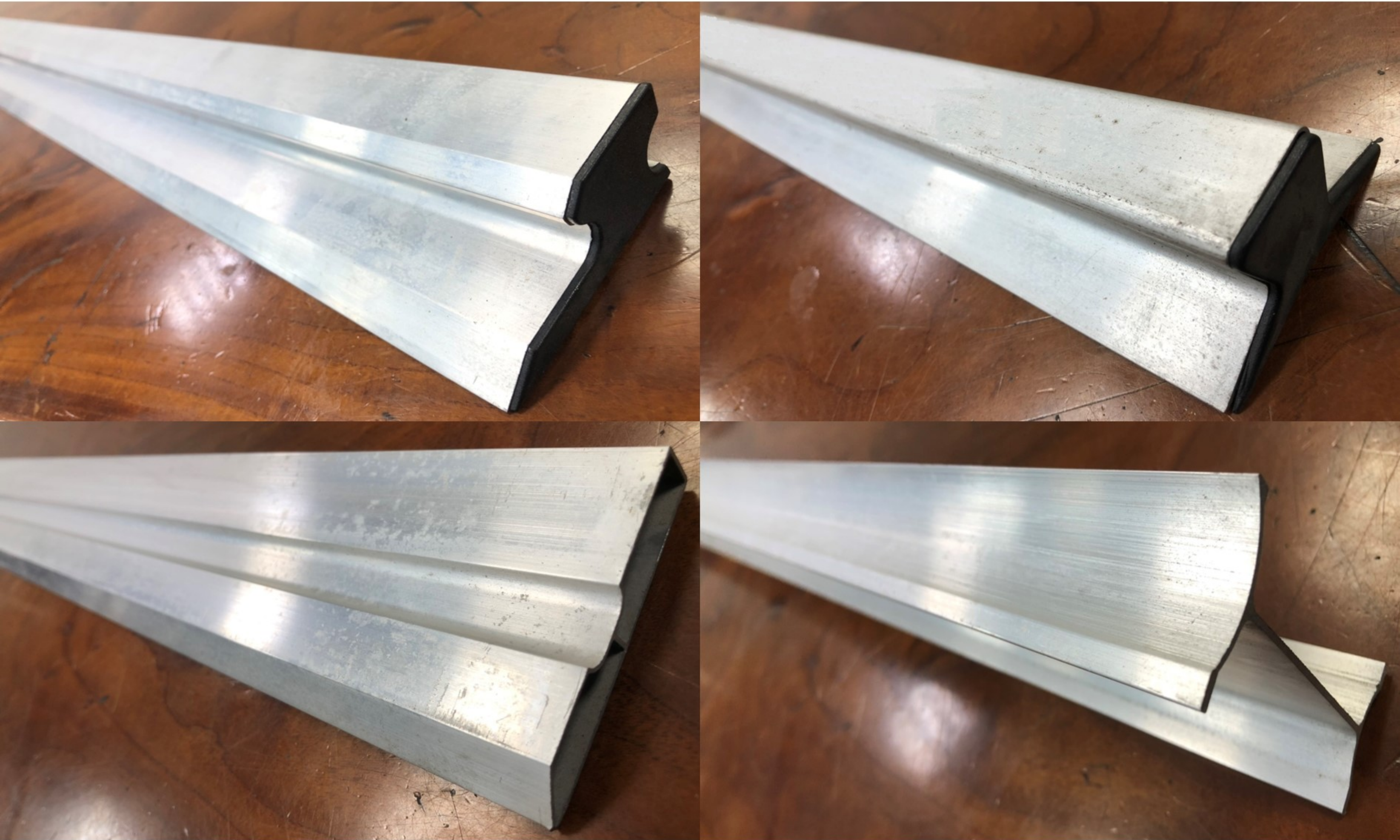

## Product description:

It is used for finishing and leveling the plaster to make the wall surface more smooth, even on dry stucco surface.

## Feature:

Improve working efficiency and make the walls perfectly smooth.

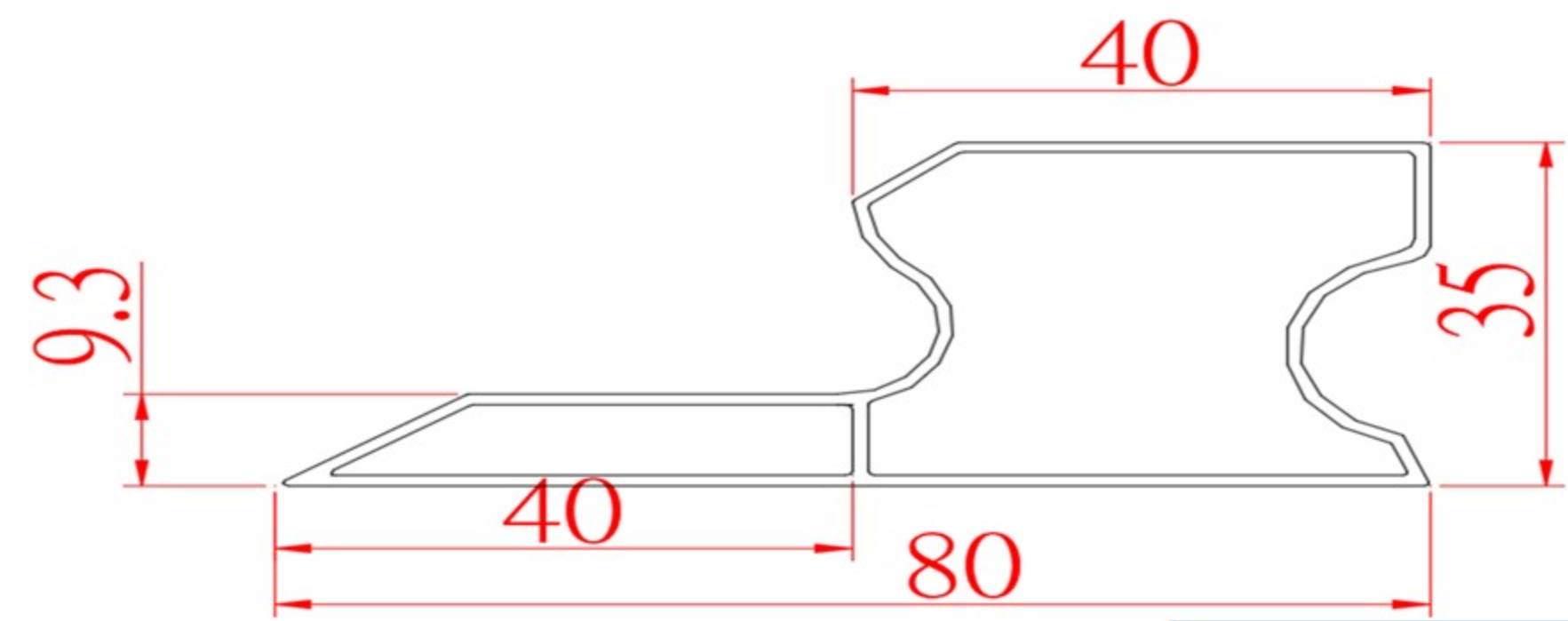

PH64A, Length 1.8m

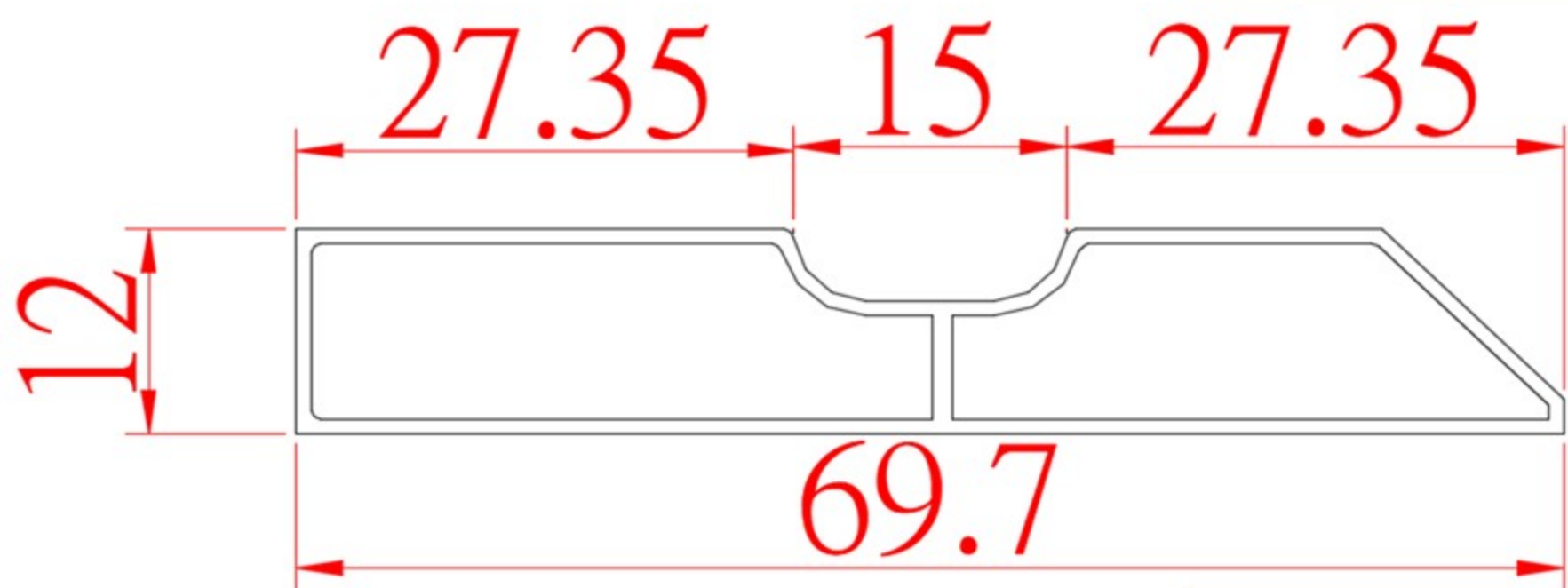
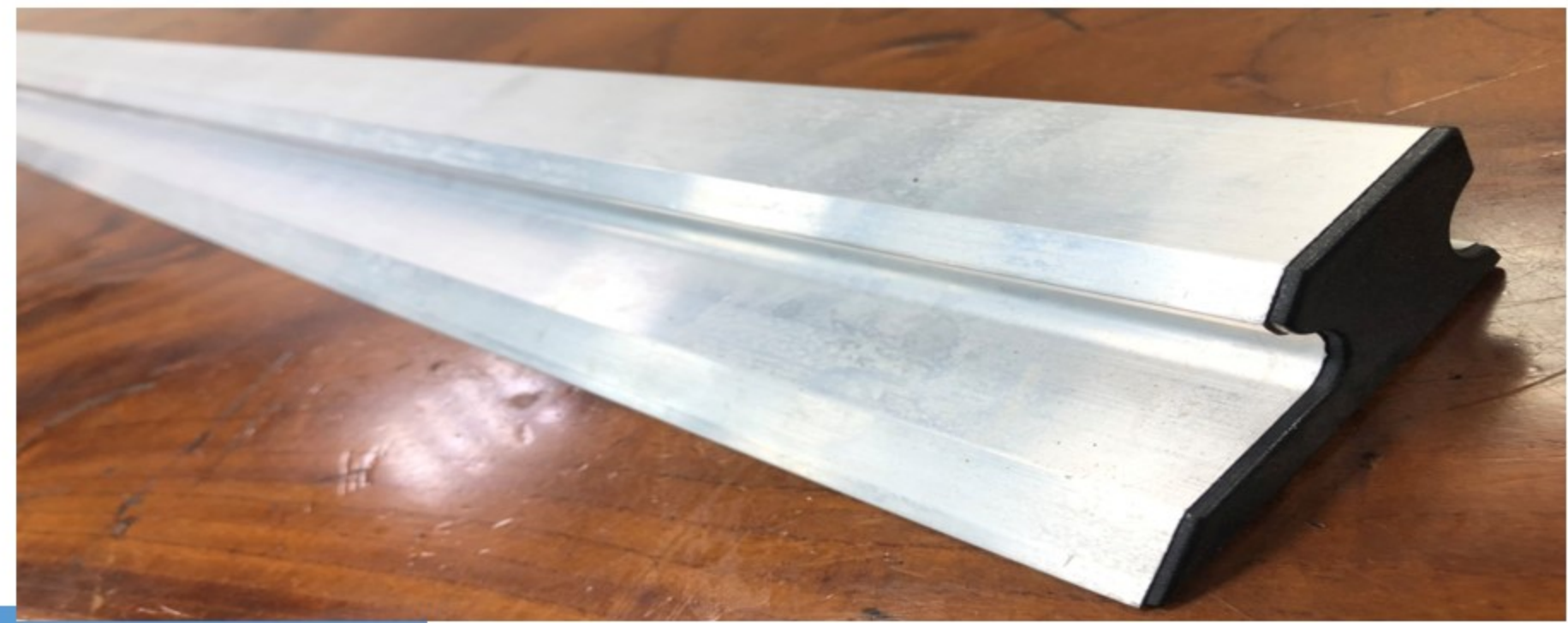

PH61B, Length 1.8m

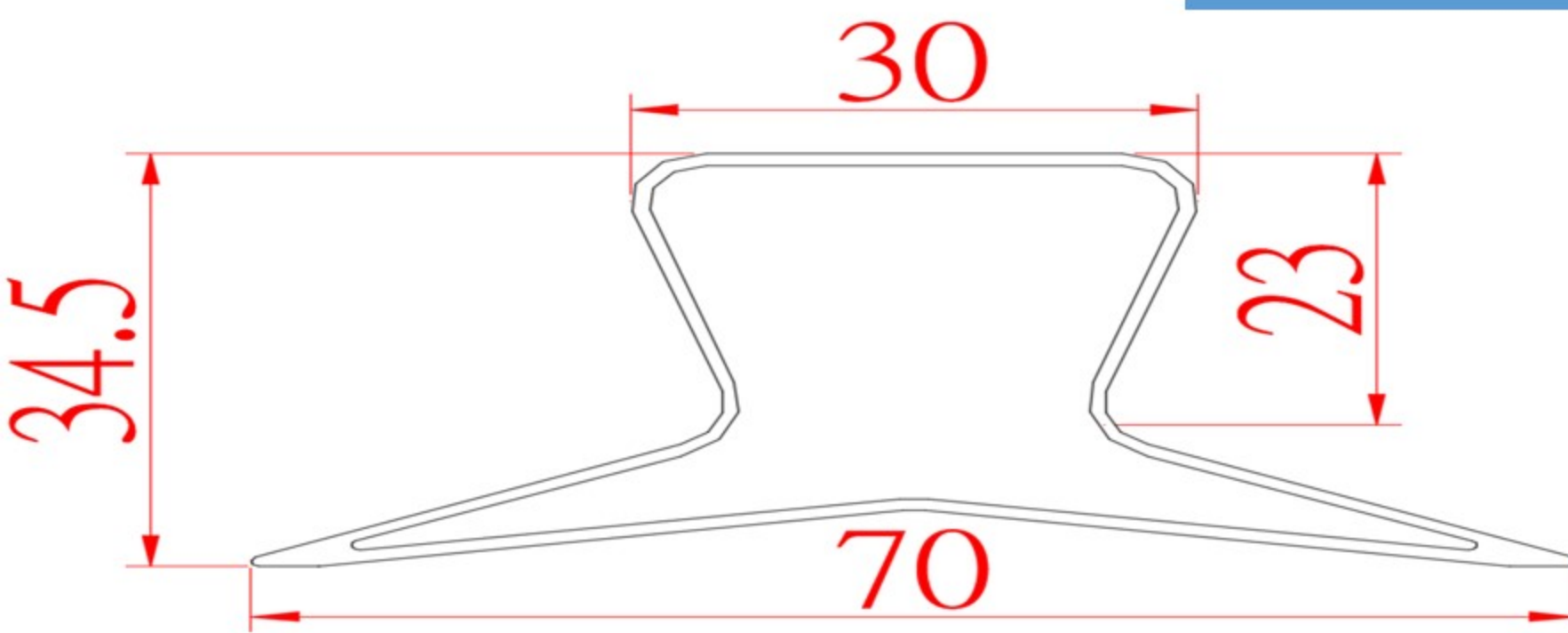
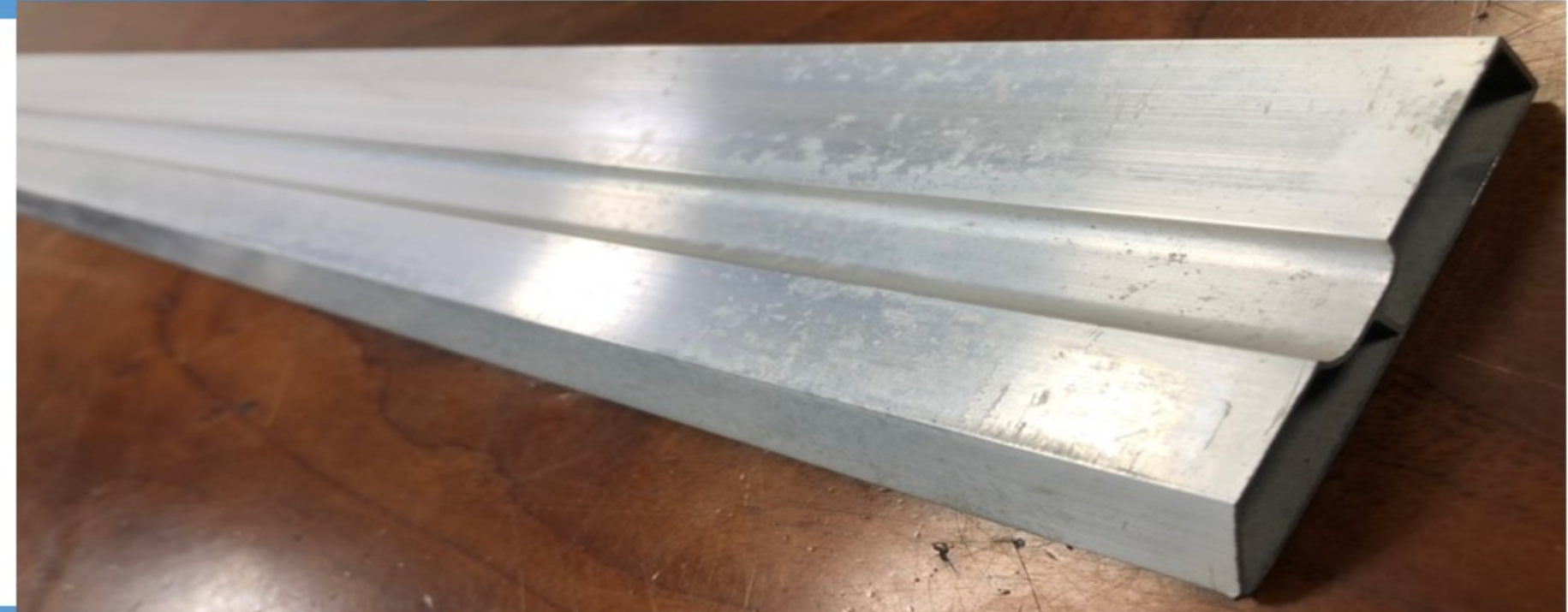

PH63C, Length 1.8m

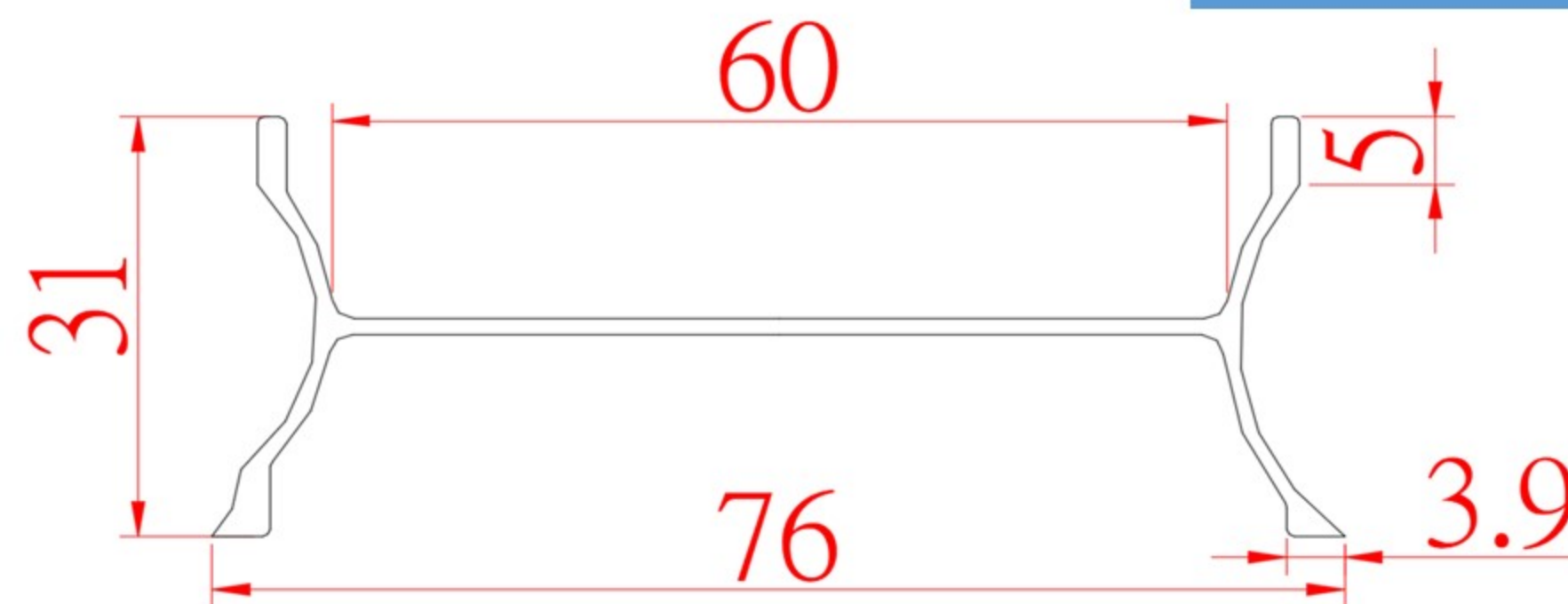

PH62D, Length 1.8m

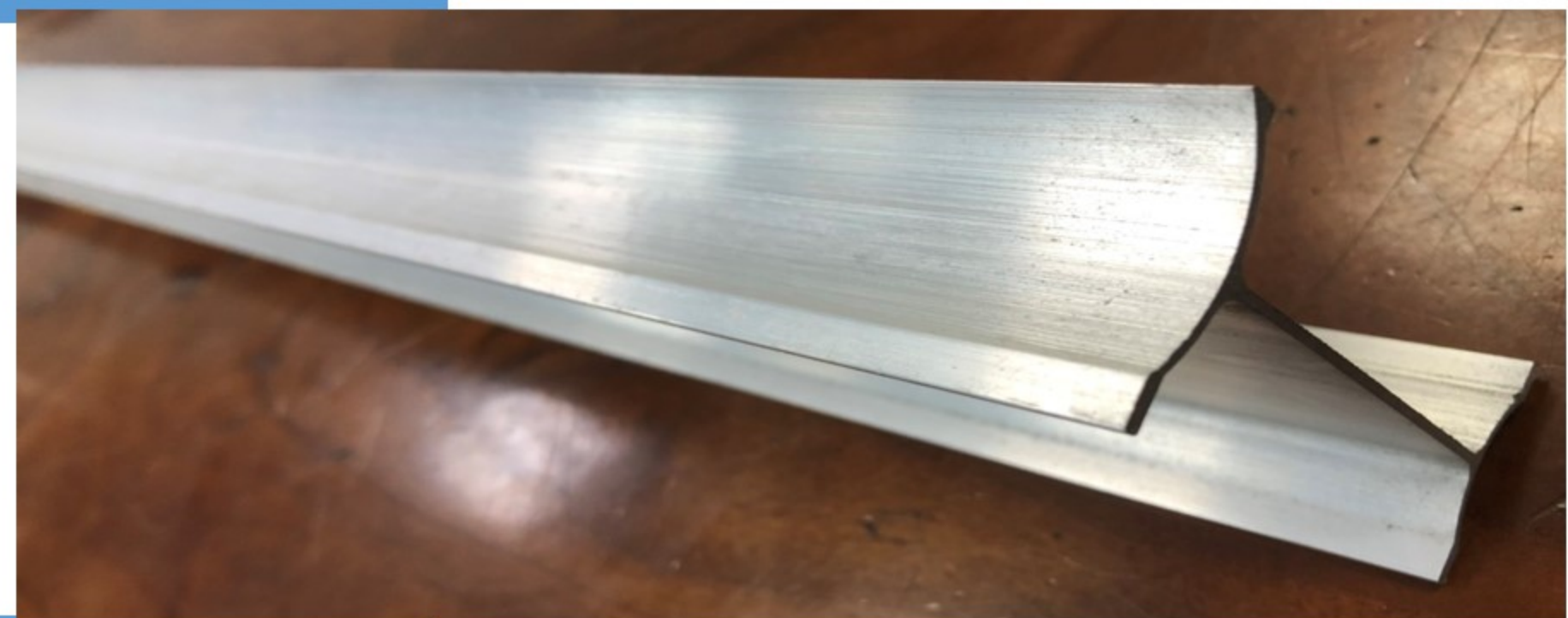

# Steel Scraping Ruler

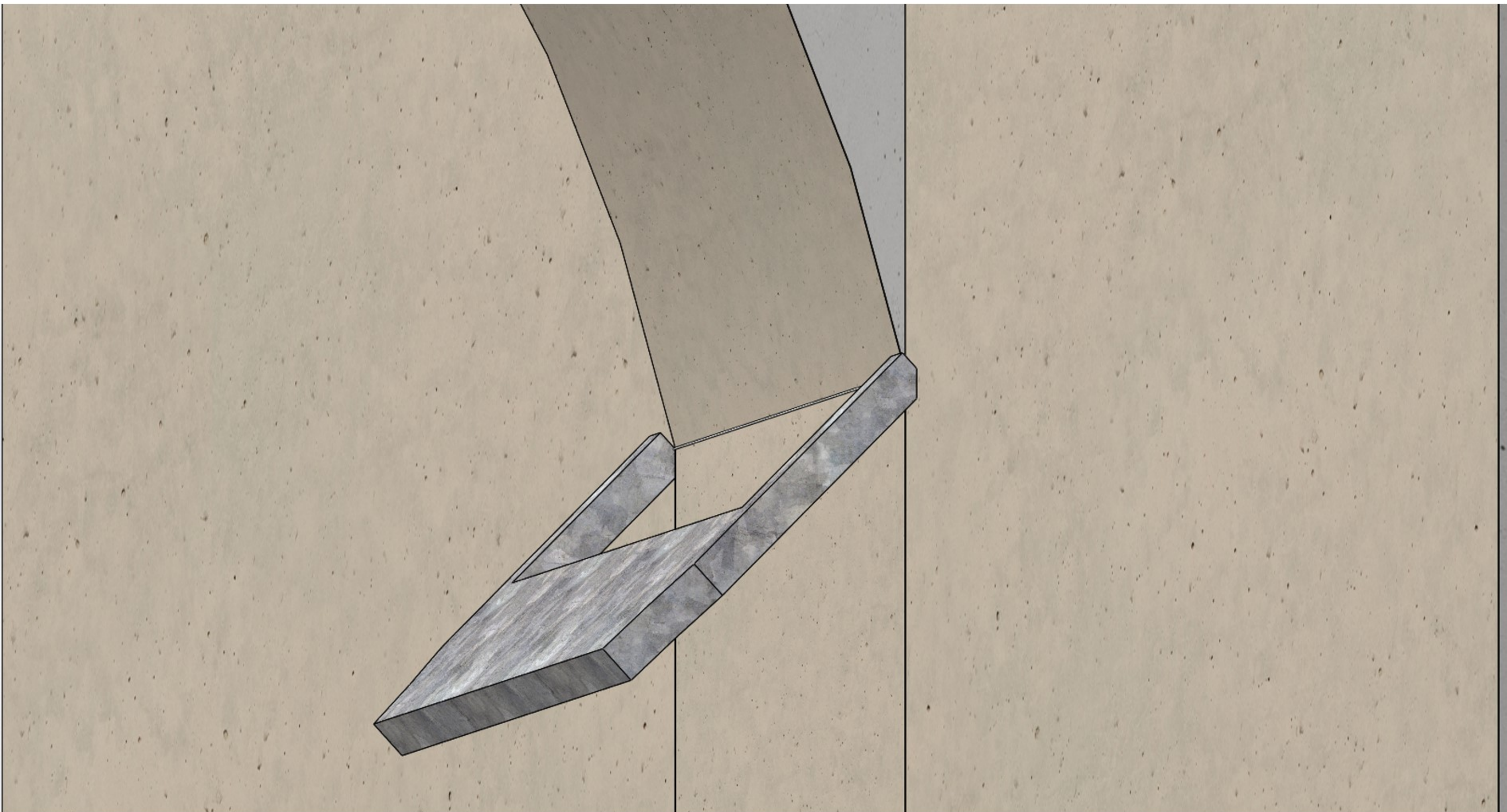

## Product description:

It is used for finishing and leveling the plaster to make the wall surface more smooth, even on dry stucco surface.

## Feature:

Improve working efficiency and make the walls perfectly smooth.

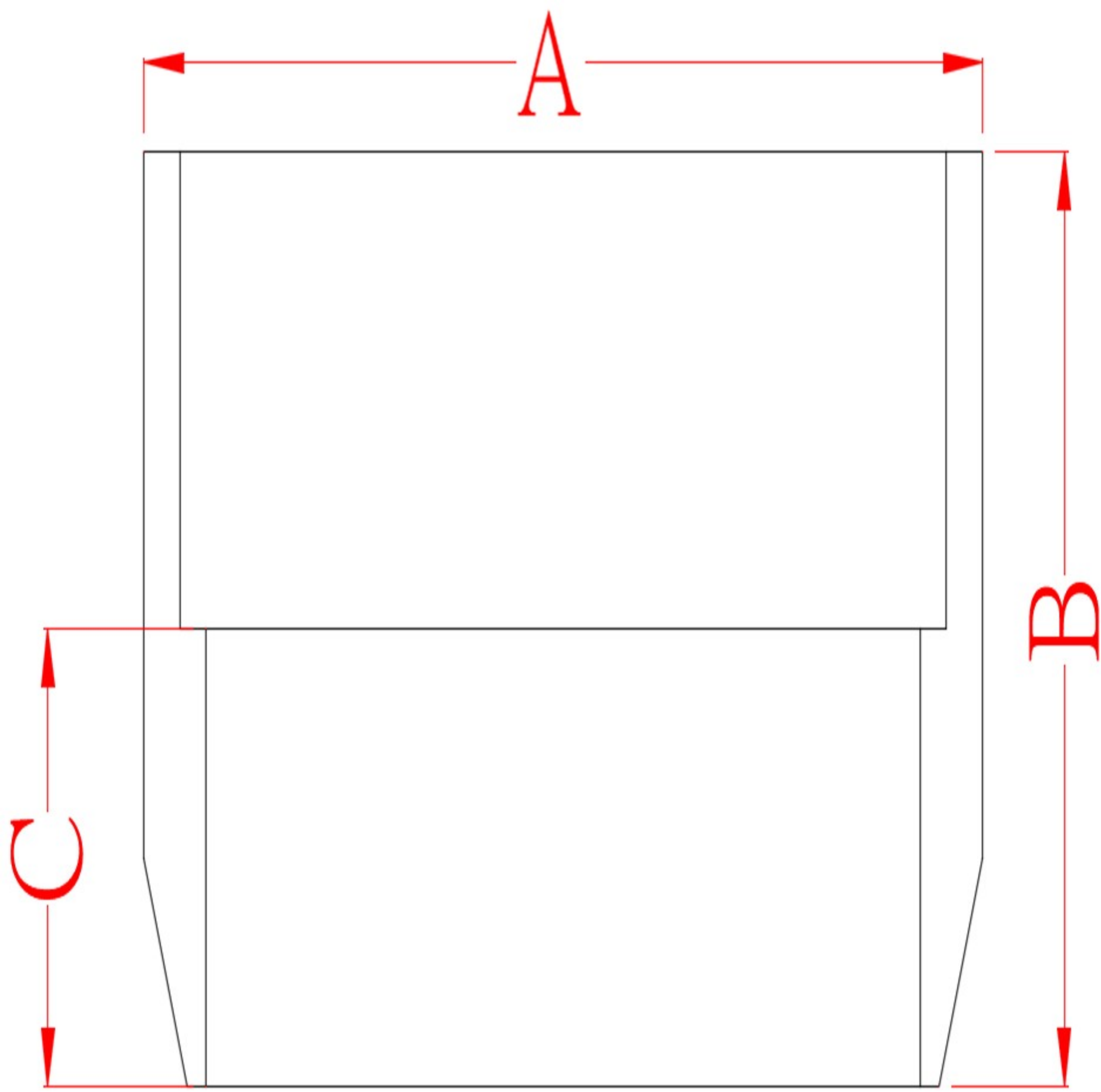

	A(mm)	B(mm)	C(mm)
PH65-2M	600	82.6	40
PH65-3M	900	82.6	40
PH65-4M	1200	82.6	40
PH65-5M	1500	82.6	40
PH65-6M	1800	82.6	40
PH65-7M	2100	82.6	40

# PVC Flat Bar

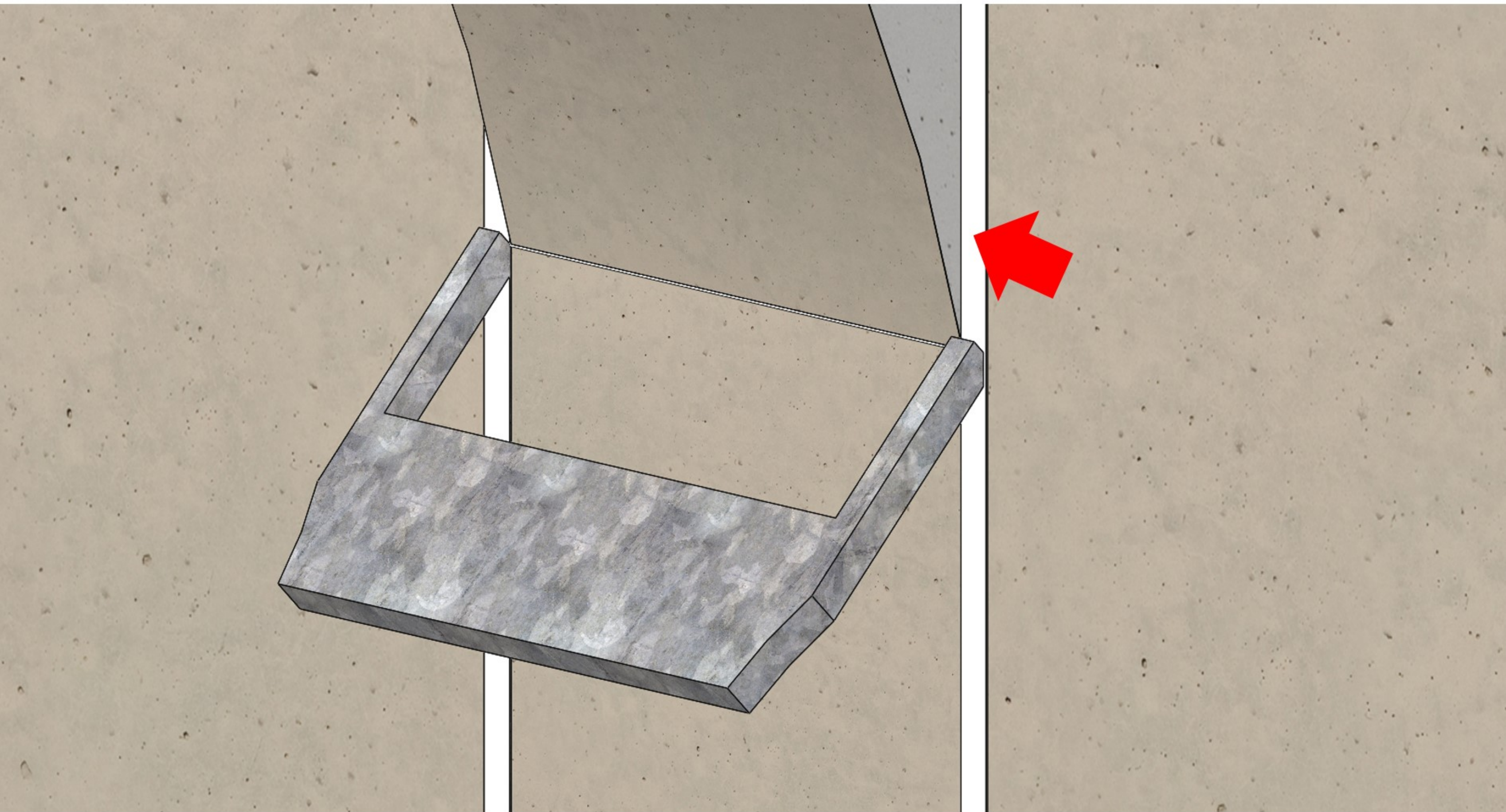

## Product description:

It is used to support steel scraping ruler to avoid shaking hands when leveling the plaster.

## Feature:

Improve the leveling process and avoid time-consuming work.



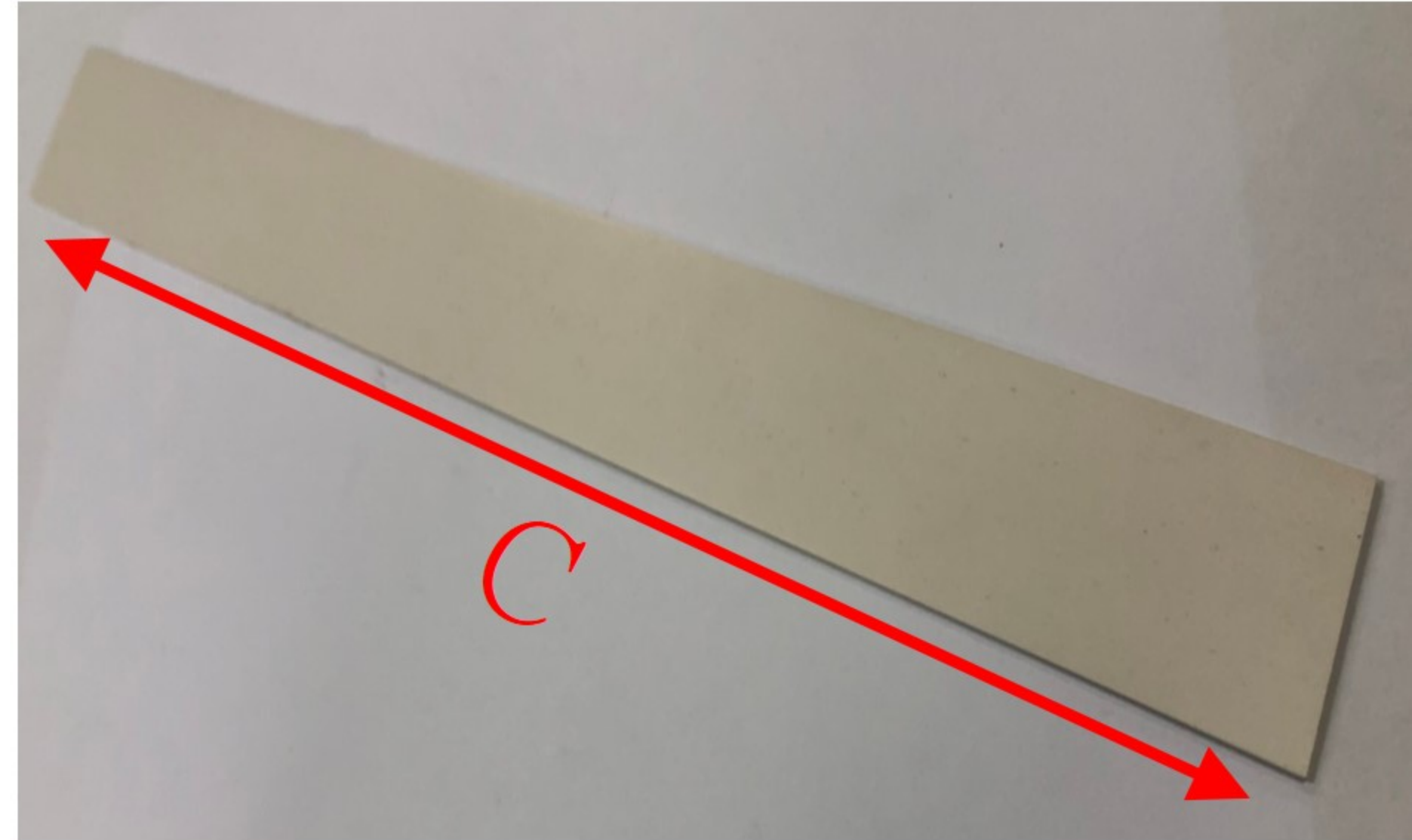
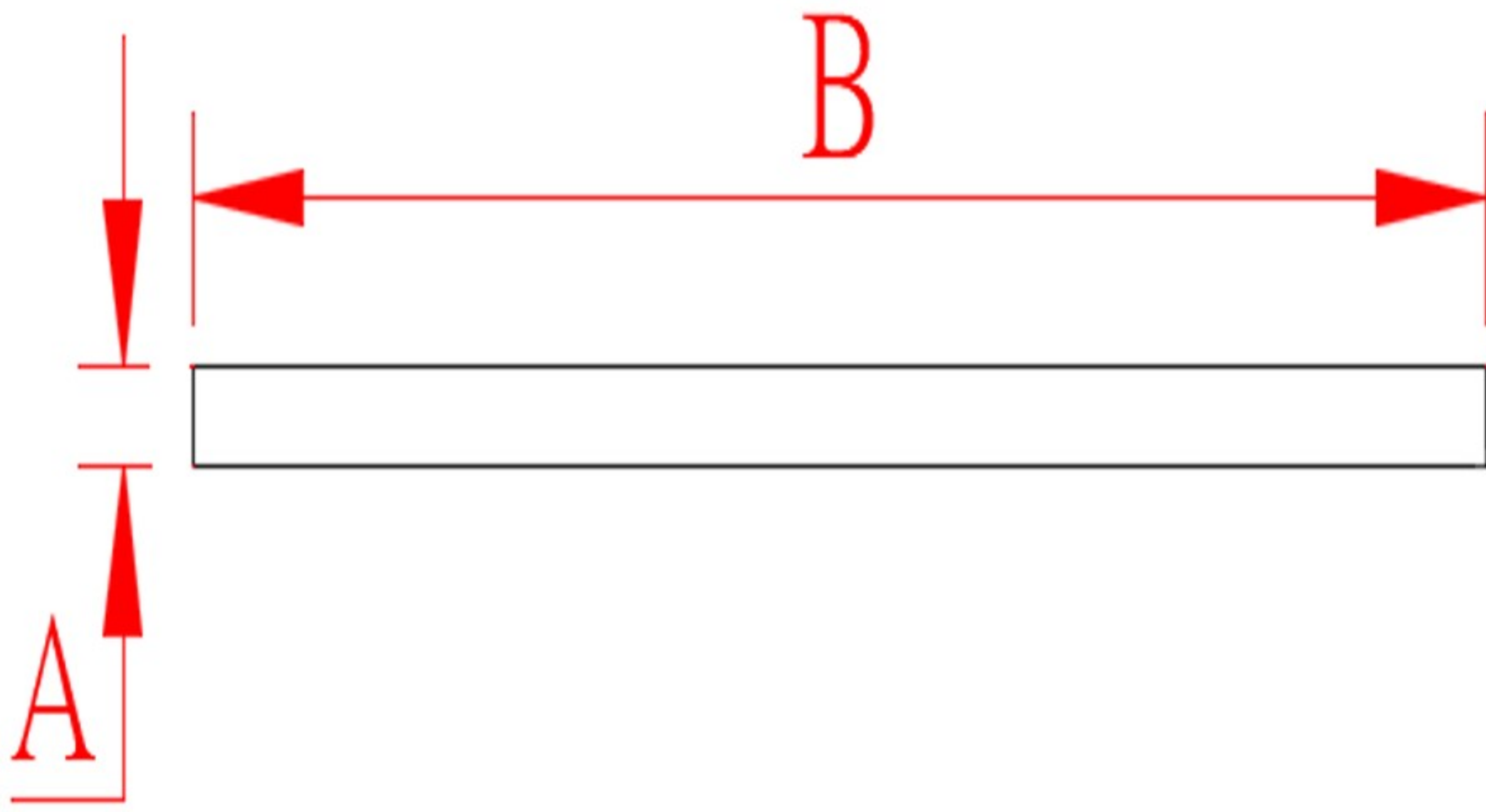

A(mm)

B(mm)

C(m)

PI5911-1

1.5

30

2.0

# Fitting of Glazed Roof Tile Interlocking (1)

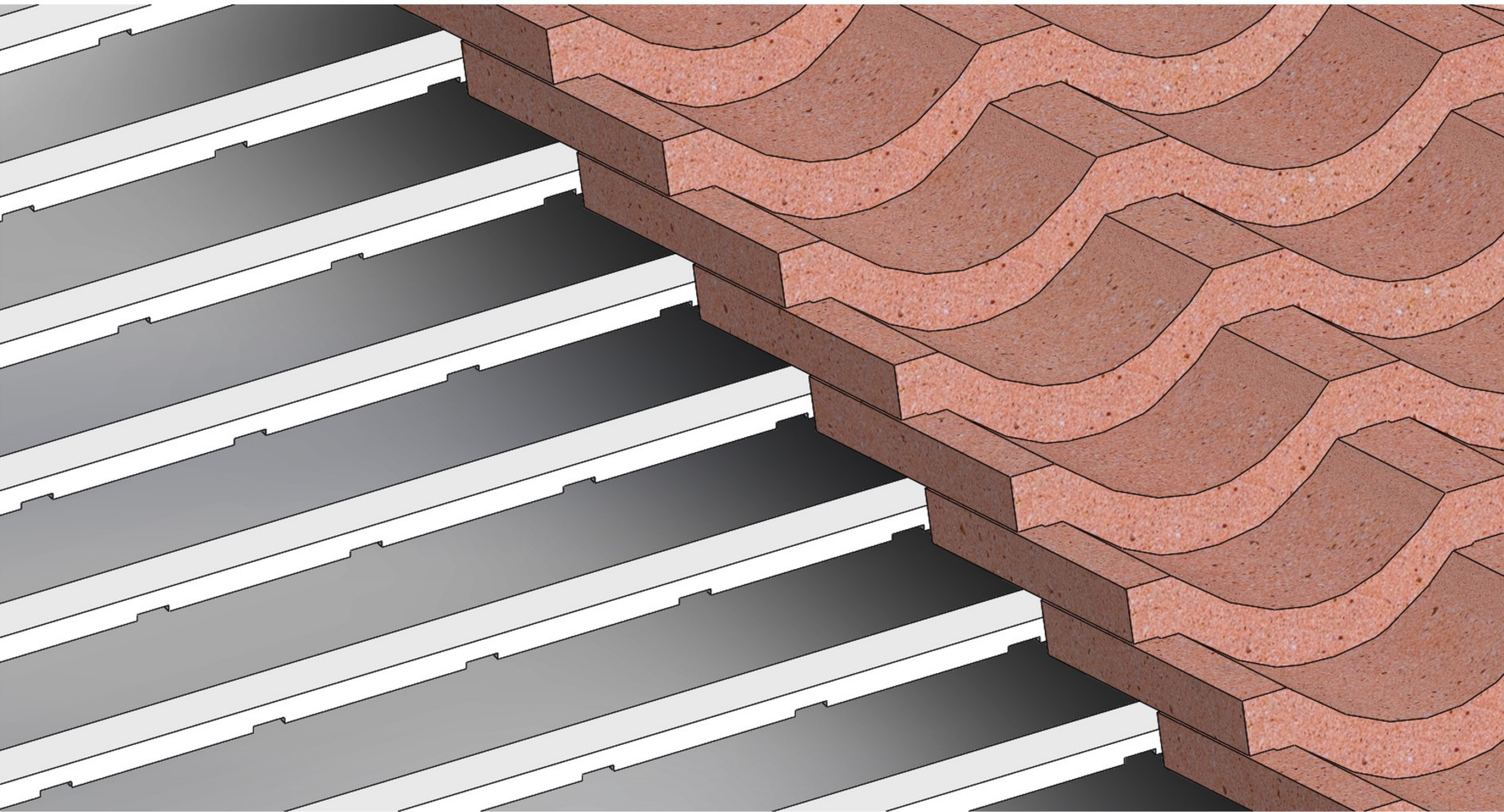

## Product description:

This fitting can be used as interlocking when install Chinese glazed roof tiles to make the roof tile more steady.

## Feature:

Made of PVC with anti-corrosion

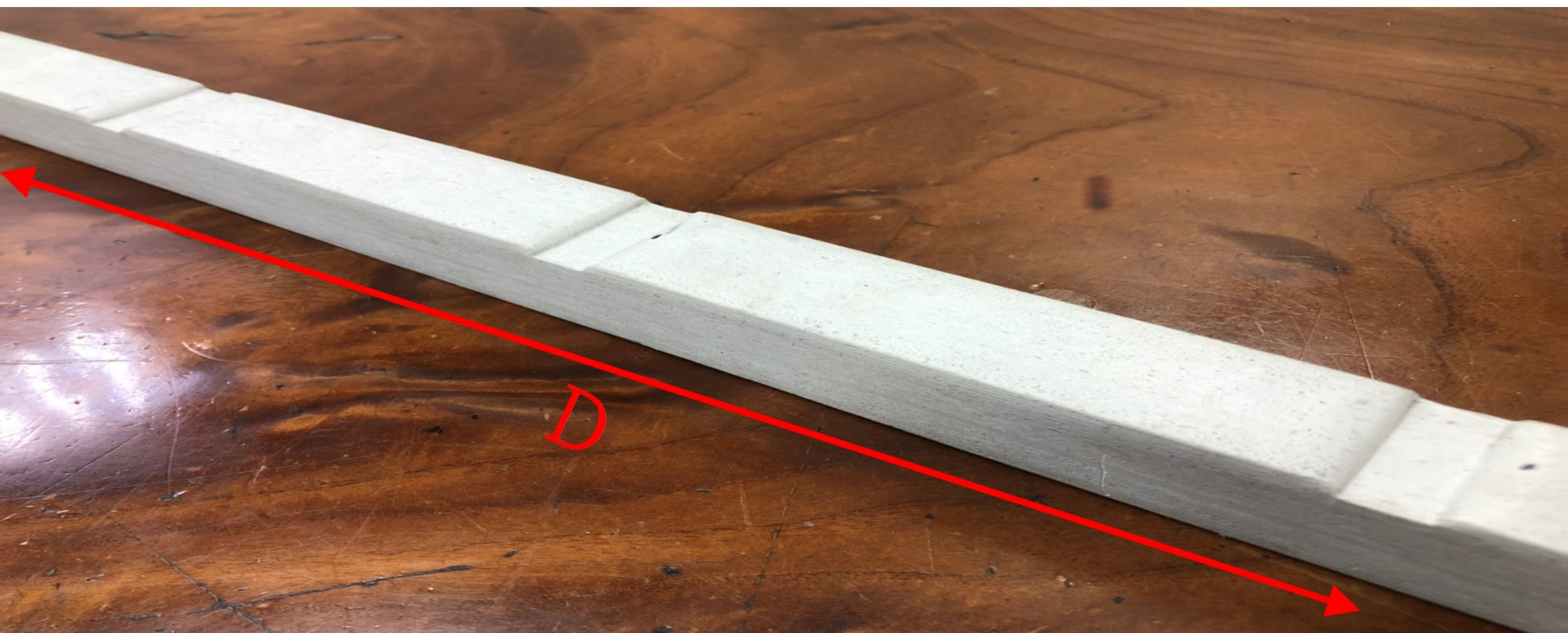
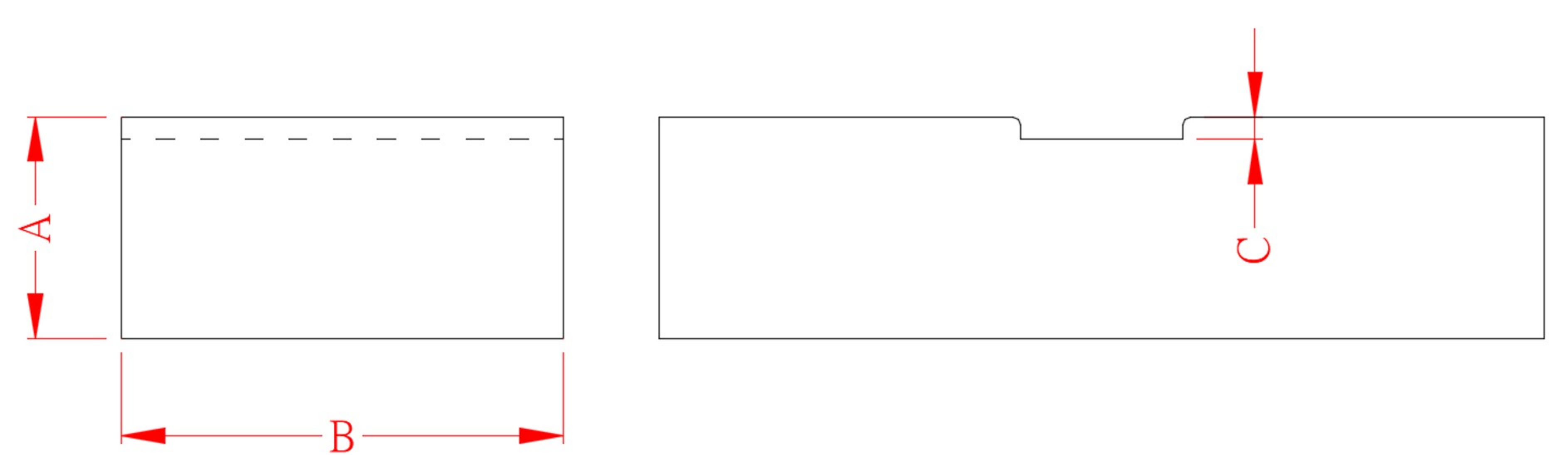

	A(mm)	B(mm)	C(mm)	D(m)
PBQD-C	15	30	1.5	1.8
PBQD-D	30	30	1.5	1.8

# Fitting of Glazed Roof Tile Interlocking (2)

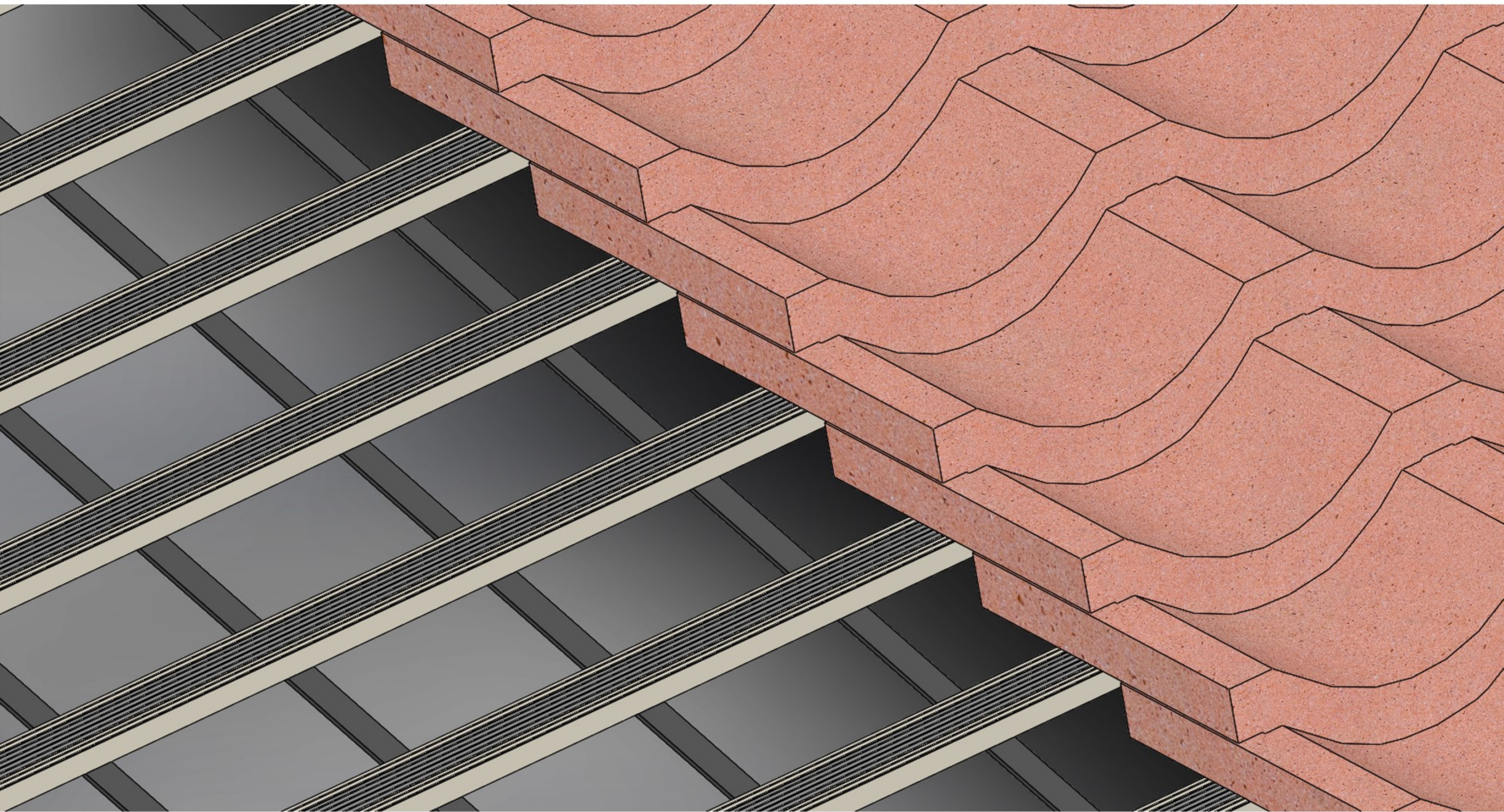

## Product description:

This fitting can be used as interlocking when install Chinese glazed roof tiles to make the roof tile more steady.

## Feature:

Made of PVC with anti-corrosion

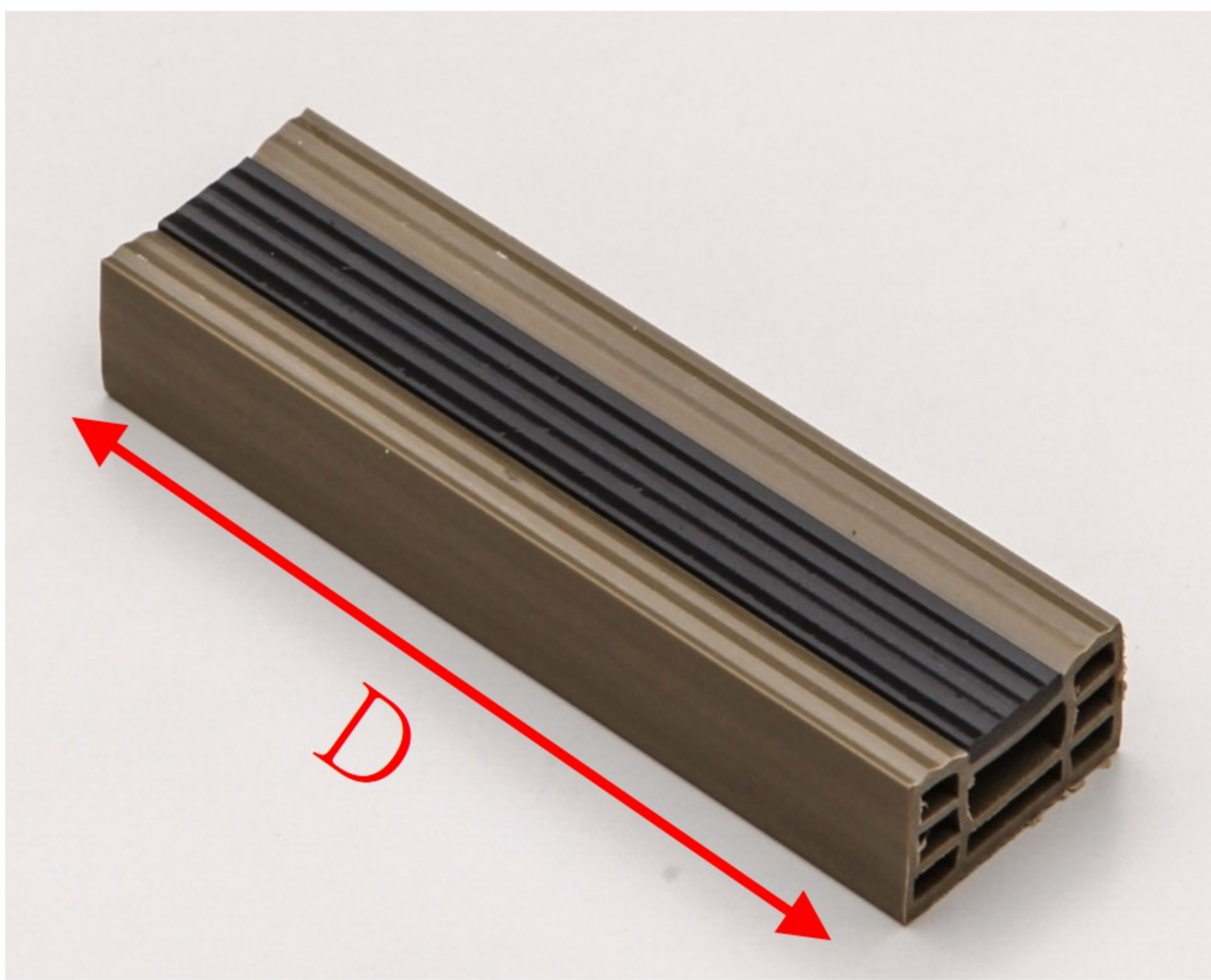
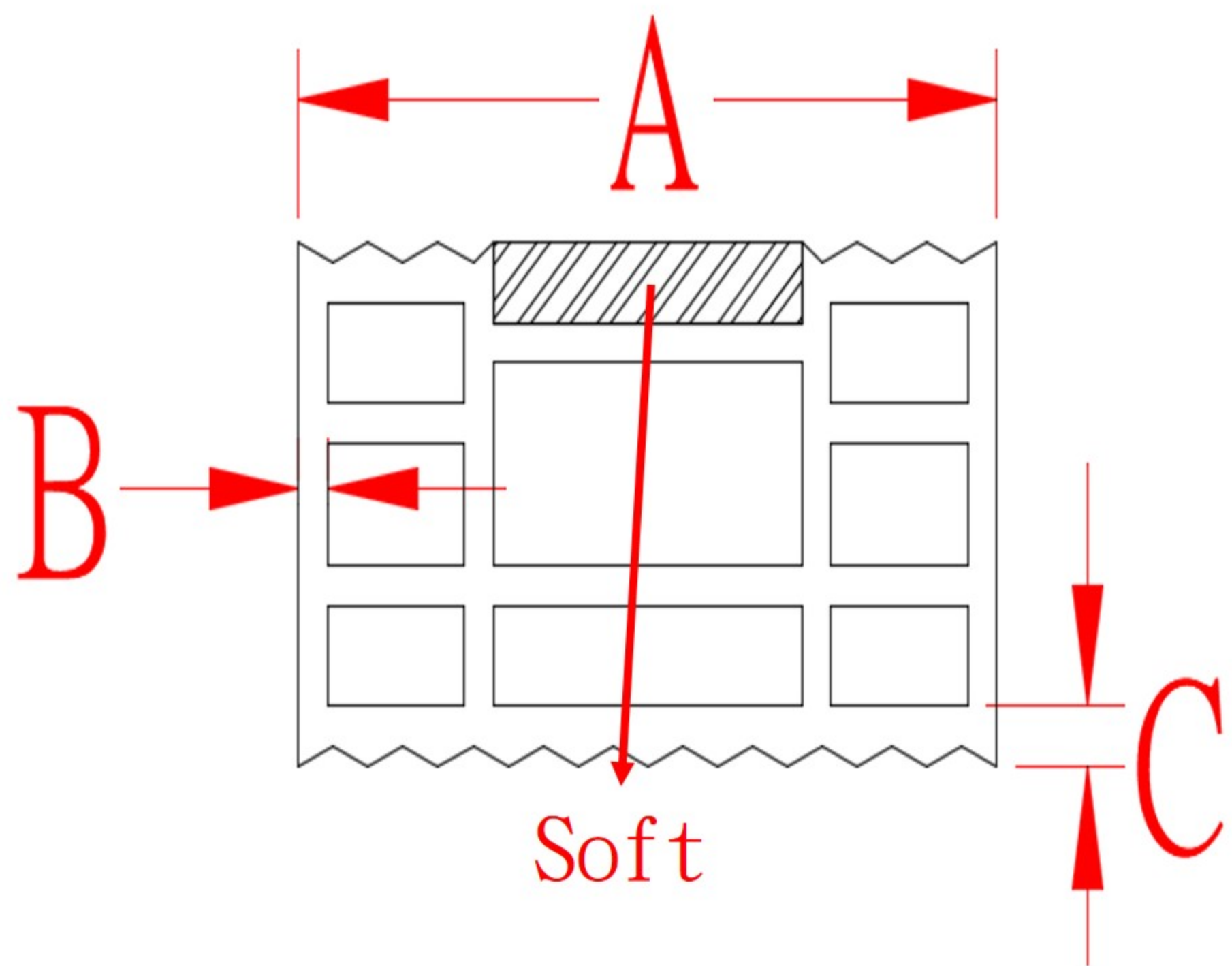

A(mm)

B(mm)

C(mm)

D(m)

PBQD-B

23.6

1

1.5

1.8

# Drain Bar

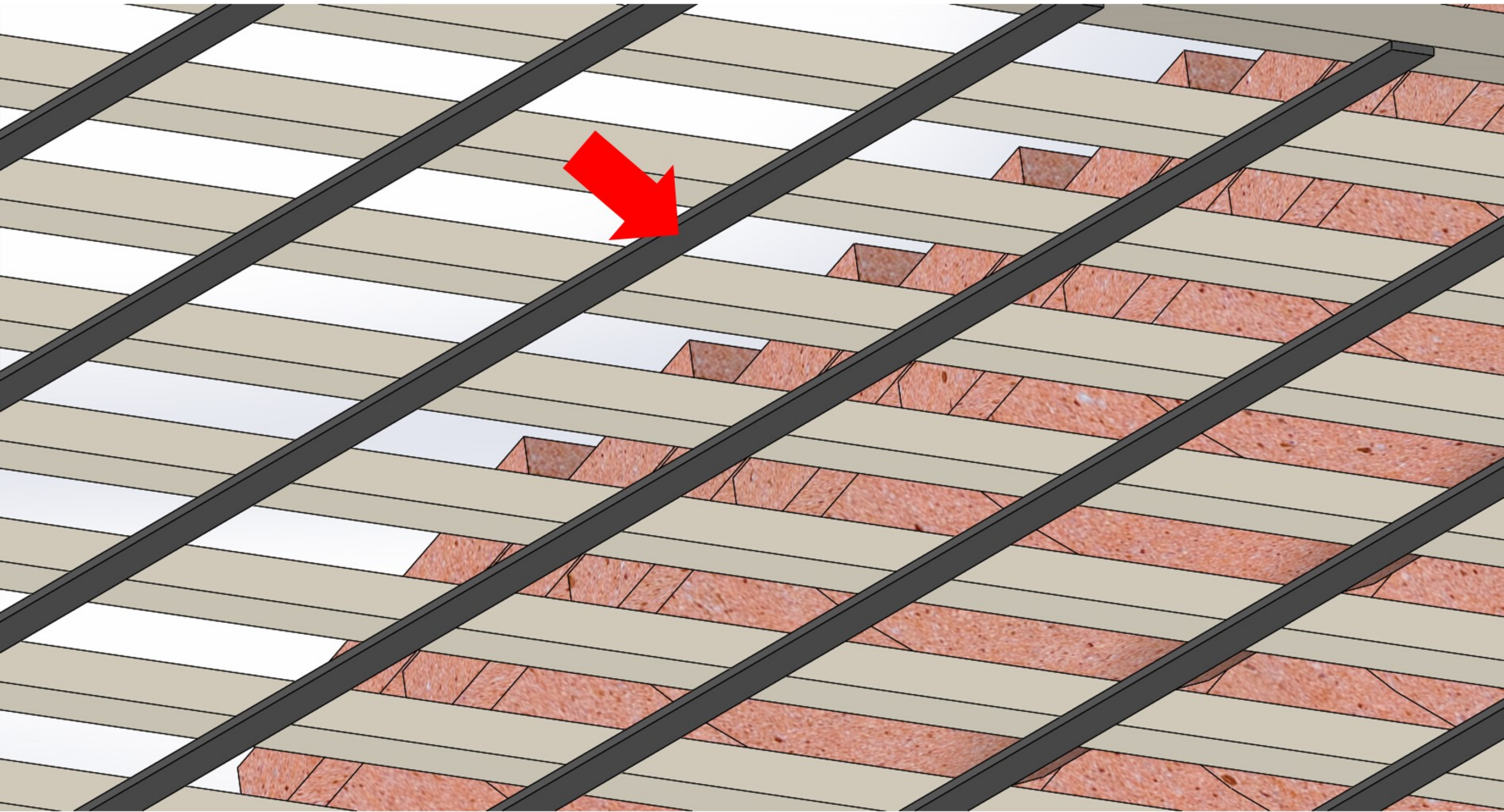

Product description:

Drain Bars provide to terminate the roof, and allow water to flow over the edge to avoid large puddles form on the roof.

Feature:

It is made to improve drainage.

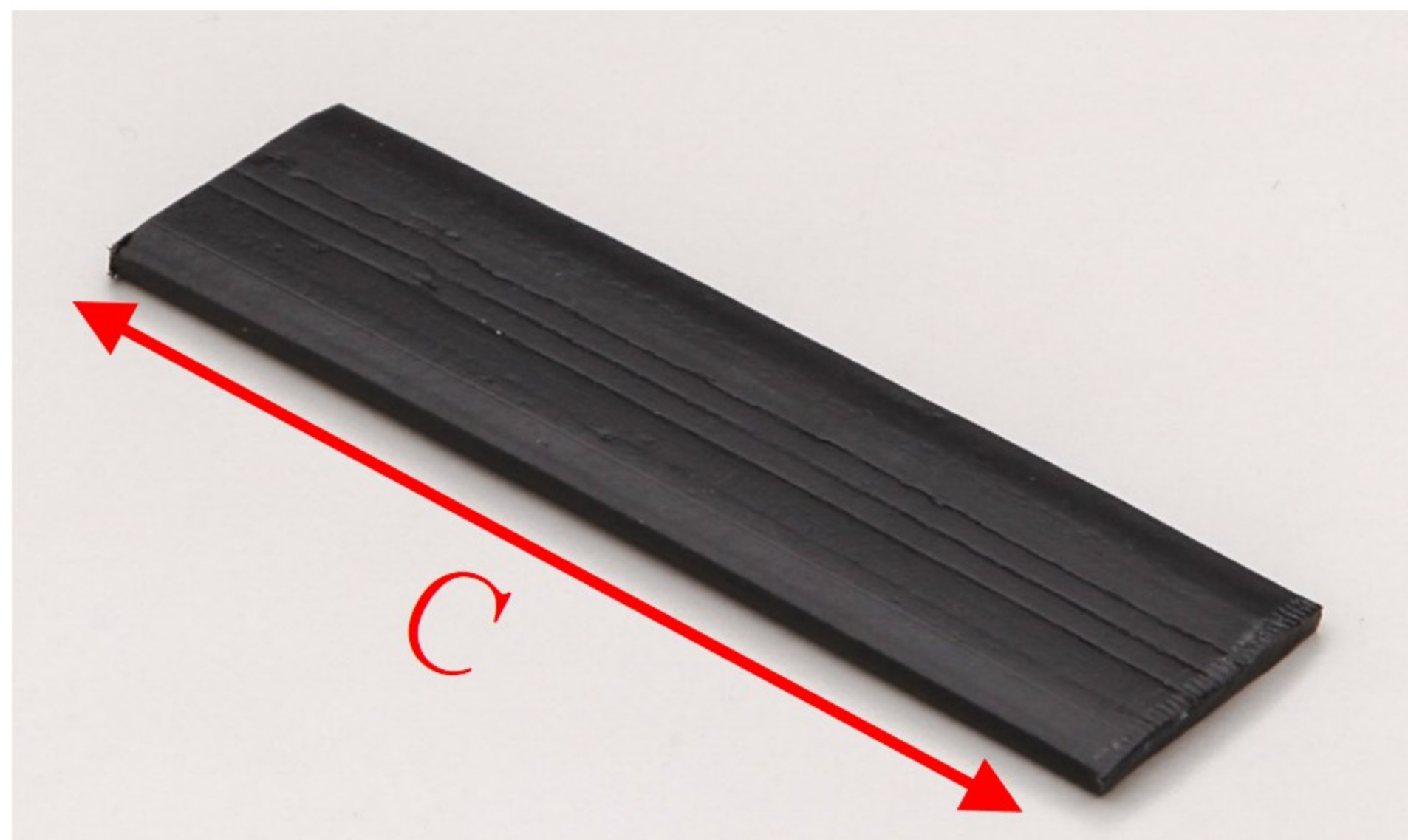
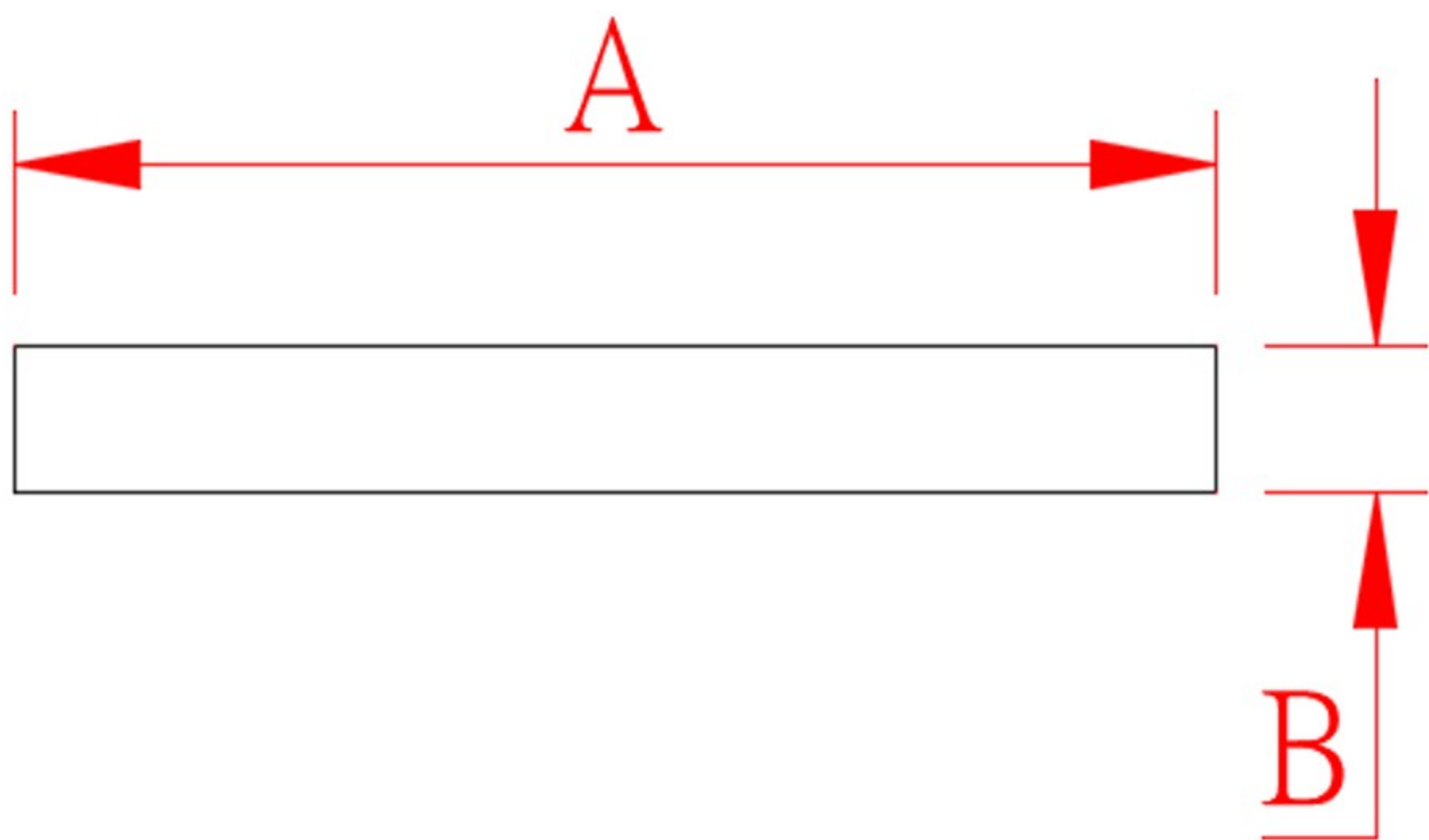

A(mm)

B(mm)

C(m)

PBQE-E

24

2.8

1.8



# Cement Filler Gun (Caulking Gun)

## Product description:

Fill cement into the filler gun and apply fully in the gap between window frame and wall. It can also use on perpendicular joint filling.

## Feature:

- 1.Improve working efficiency on gap filling and avoid time-consuming process.
- 2.With 20kg/ 200N of force and easily extrudes the succo.





PH000-01  
Nozzle: 10mm\*100mm



PH000-03  
Nozzle: 5mm\*100mm



PH000-04  
Nozzle: 15mm\*100mm



PH000-05  
Nozzle: 22mm\*22mm



PH000-06  
Nozzle: 10mm\*100mm



PH0000B1  
(include 01,04,05,06)

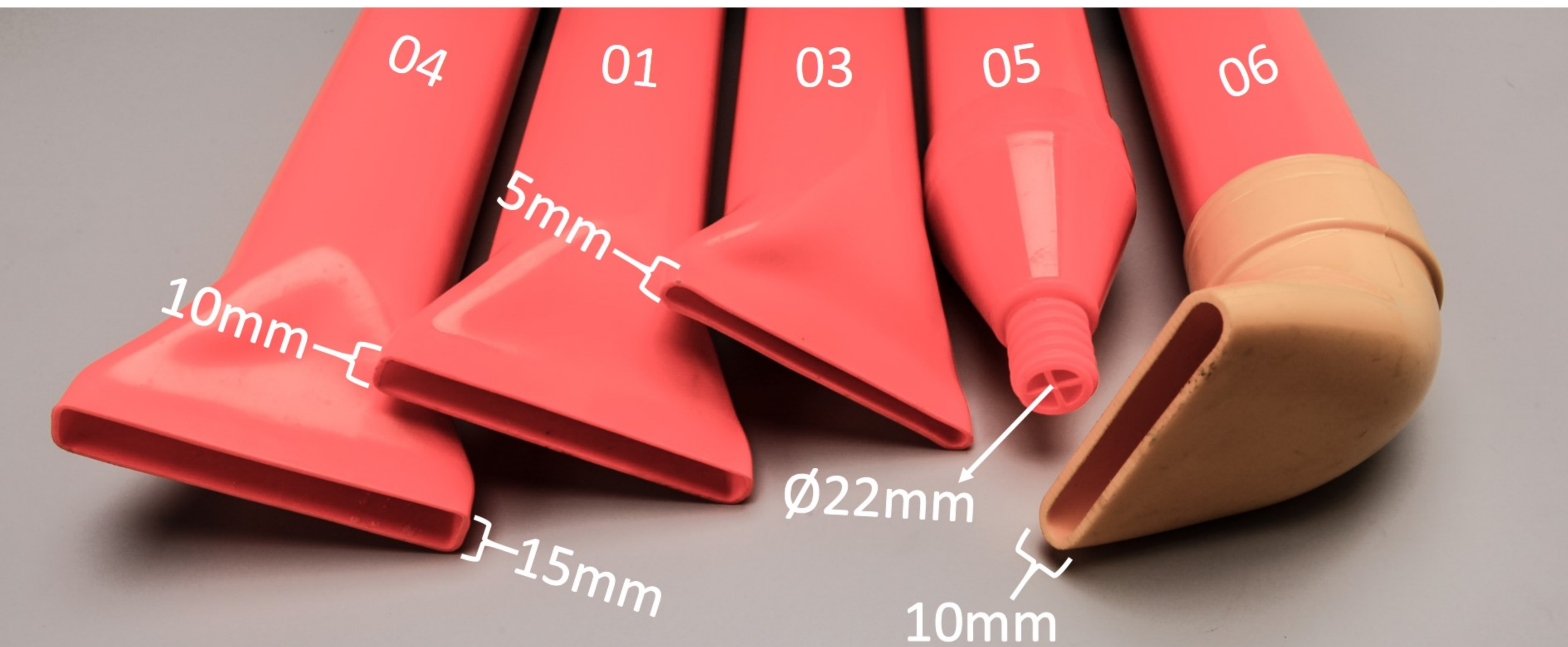

# Blow-out Pump



Product description:

It is ideal for cleaning dust after hole drilling.

Feature:

Remove dust ensures rated load capacities are achieved.



Ø60mm

375mm

65mm

PH000008